

# Pumping Station Addendum

**(To be read in conjunction with) Design  
and Construction Guidance (Appendix C)  
of the sewerage sector guidance,  
Company local practice in accordance  
with Sewerage Adoption Code**

DECEMBER 2019

**AMENDMENT SUMMARY**

Issue	Date	Details	Owner	Verified by
1	Oct 14	Original Issue in conjunction with SFA 7th Edition		
2	Dec 19	General review and amendments in accordance with Sewerage Sector Guidance Appendix C	V Shannon J Robinson D McKinley Bourne	S Mercer N Ratcliffe

## Contents

<b>1. PURPOSE</b>	<b>4</b>	F2.3.16	Pump Unit Protection Sensors	8
<b>2. PROCUREMENT</b>	<b>4</b>	F2.4	Testing	9
<b>3. HAZARDOUS AREA RATING</b>	<b>4</b>	F2.4.1	General	9
<b>4. DESIGNER'S RESPONSIBILITIES</b>	<b>5</b>	F2.4.2	Testing on site	9
<b>5. PART D – PUMPING STATIONS</b>	<b>5</b>	<b>F3</b>	<b>ELECTRICAL</b>	<b>9</b>
<b>D2</b>	<b>SCOPE</b>	F3.3.4	Earthing and Bonding	9
D5.3	Site Layout	F3.3.4.1	General	9
D5.4	Kiosk Positioning	F3.3.5.4	Termination of wiring	9
D5.6	Hydraulic Design of Pumping Stations	F3.3.5.4.1	General	9
D5.7	Pumping Station Design	F3.3.7	Connection for a mobile generator	9
D6.2	Reliability	F3.3.8	Abnormal Operation	9
D6.3	Hydraulic Design	F3.3.8.3	Interruption/loss of ultrasonic signal	9
<b>D7</b>	<b>DESIGN OF PUMPING STATIONS</b>	F3.3.8.5	Wet Well Level Monitoring	9
D7.1	General	F3.3.9	Telemetry Signals	9
D7.2	Hazardous areas	F3.3.10	Ultrasonic Level Controller (ULC) Specification	10
D7.3	Wet Well - General	F3.3.10.3	Functionality	10
D7.4	Wet Well – Structural Design	F3.3.11	Functional Units – Form 4 assemblies	10
D7.5	Valve chamber	F3.3.11.2	Incomer compartment	10
D7.6	Flow metering	F3.3.11.4	Motor starter compartments	10
D7.7	Access into Wet Well, Valve Chambers and Flow meter Chambers	F3.3.11.5	Common control compartment	10
D7.8	Cable Ducts	F3.3.12	Functional Units – Form 2 assemblies	10
D7.10	Kiosk	F3.3.12.3	Incomer	10
D7.11	Kiosk construction	F3.3.12.5	Motor starters	10
	Figure D4	F3.3.12.6	Common control compartment	10
		F3.4.1.5	Junction boxes	10
<b>6. PART F – MECHANICAL AND ELECTRICAL SPECIFICATION FOR SMALL PUMPING STATIONS</b>		F3.4.4	Installation of cables	10
<b>F1</b>	<b>GENERAL</b>	F3.4.6	Earthing and Bonding	10
F1.1	Hazardous area appliances	F3.4.6.1	General	10
F1.2	Operation and maintenance documentation	F3.4.6.2.	Earth electrode	11
<b>F2</b>	<b>PUMP UNIT SPECIFICATION</b>	F3.4.6.3.	Bonding	11
F2.2	Performance Requirements and Information	F3.4.6.3.3	Supplementary equipotential bonding Figure F.3	11
F2.3.3	Noise	F3.5	Instrumentation	11
F2.3.5	Pump casings	<b>F4</b>	<b>Valve specification</b>	
F2.3.6	Impellers	F4.1	Gate (sluice) valves	11
F2.3.9	Bearings and bearing lubrication	F4.2	Check (reflux) valves	11

## 1. PURPOSE

This addendum sets out those requirements that are specific to United Utilities (UU) where a developer wishes to design and construct a pumping station for inclusion within an adoption agreement. The clauses within this document are referenced to Sewerage Sector Guidance Appendix C Version 1.0 and follow on from the clauses detailed within the main document.

It is intended that this addendum, in conjunction with Sewerage Sector Guidance, will provide specific guidance for the design and general specification of sewerage elements involved when making an application to UU.

This addendum does not remove the need for early engagement and constructive discussions between UU and developers at appropriate stages or where site specific factors need to be addressed in advance of making an application.

For discussions where a pumping station is to form part of an adoption agreement, developers should contact the 'Developer Services Team' at the following address:

### United Utilities Water PLC

Grasmere House  
Lingley Mere Business Park  
Lingley Green Avenue  
Great Sankey  
Warrington  
WA5 3LP

Email address: [wastewaterdeveloperservices@uuplc.co.uk](mailto:wastewaterdeveloperservices@uuplc.co.uk)

The clause numbers below refer to those in Sewerage Sector Guidance Appendix C Version 1.0. These clauses are supplementary and follow on from the clauses listed in the main document except where the sub clause number is prefixed by:

- an '(A)', in which case it is an additional clause,
- or '(D)', in which case it is a deletion of that clause,
- or '(R)', in which case it is a replacement clause.

## 2. PROCUREMENT

The equipment should be selected from UU's Framework Suppliers (for details of Suppliers contact UU) and associated standard drawings in accordance with the relevant UU Framework Agreements. Where the design solution requires the procurement of equipment that can only be obtained from a non-framework supplier, the developer shall specify the requirements as part of the particular design specification for the scheme or contract.

The applicable product areas detailed within this addendum and associated standard drawings are:

- Pumps
- Low voltage switchgear and control gear assembly (electrical control panels)
- Instrumentation
- Telemetry

Where a product is available from more than one Framework Supplier, or there are no relevant Framework Agreements, the final selection for technically compliant submissions shall be made with reference to UU Procurement Guidelines (available on request from the UU Commercial Regulatory Procurement Team) and shall be based on lowest whole life cost and sustainability analyses.

## 3. HAZARDOUS AREA RATING

All equipment installed in wet, or dry wells, shall be rated according to the hazardous area classification of the area in which they are to be installed.

Guidance on how to comply with the UU's hazardous area classification can be found in the current versions of specific UU documents which are available on request from the UU Engineering team.

All hazardous areas shall comply with DSEAR and UU H&S Procedure "Dangerous Substances and Explosive Atmosphere Regulations".

The selection, installation and maintenance of mechanical and electrical apparatus for use in potentially explosive atmospheres shall be in accordance with UU Code of Practice "Installations in Potentially Explosive Atmospheres Associated with Water and Wastewater".

## 4. DESIGNER'S RESPONSIBILITIES

The designer aspects of the mechanical and electrical design of the station shall take into account the requirements, stipulations and recommendations contained in UK safety legislation.

## 5. PART D – PUMPING STATIONS

### D2 Scope

Clause 3 (A) – Compliance with the features and guidance set-out in Sewerage Sector Guidance Appendix C as modified by UU's Addendum, will be deemed to provide an efficient and cost effective design, **for the whole Asset Life cycle & Maintenance**, meeting UU's specific requirements.

### D5.3 Site Layout

Clause 5 (A) – Where security fencing is required to the pumping station compound fencing types palisade or paladin are acceptable.

Clause 8 (A) – The tanker hardstanding area shall drain into the foul system.

### D5.4 Kiosk Positioning

Clause 1 (A) (i) – Vehicle protection bollards shall be provided if the site arrangement presents a risk to the kiosk.

### D5.6 Hydraulic Design of Pumping Stations

Clause 3 (A) – 'Snore' operation requires that the pump unit shall be able to tolerate normal, fully-primed running, loss of prime and running in the condition where the impeller is neither completely in-air or primed sufficiently to pump as normal, as well as any transitions between these operating conditions. Where pump units cannot comply with this requirement, the developer shall inform UU accordingly, including a proposed solution to this non-compliance.

Clause 3 g) (A) – When in back up control, the pump shall operate on reaching the high level and run for a pre-set period to reduce the well level to empty.

### D5.7 Pumping Station Design

Clause 1b) (R) – a bespoke design in accordance with Section D7 and Part F.

### D6.2 Reliability

Clause 1 (R) – The minimum size for a rising main shall be 80 mm nominal bore providing that the nominal bore is always greater than the solids passing capacity of the associated pump units.

### D6.3 Hydraulic Design

Clause 2 (R) – The pipework roughness value (ks) used for the design shall be shown in the calculations submitted and shall be determined as follows:

- Where the rising main already exists, tests shall be conducted to establish the actual ks and this shall be the value used
- Where the rising main is to be a plastic material (such as HDPE) then the ks value to be used shall be 0.6 mm
- Where the rising main is to be a ductile, cast iron or cement mortar finished material then the ks value to be used shall be 1.5 mm

Conservative values are used to allow for the 40 year specified life assuming minimal maintenance of the rising main pipes.

Clause 3 d) – refer to comments above (ref 5.6 clause 3) on 'snore' operation.

## D7 DESIGN OF PUMPING STATIONS

### D7.1 General

Clause 3 – Refer to comments above (ref 5.6 clause 3) on snore operation.

Clause 3 g) (A) – When in back up control, the pump shall operate on reaching the high level and run for a pre-set period to reduce the well level to empty.

Clause 3 (A) – The control unit provided can be a proprietary controller with built in logic provided it is WITS compatible and UU has agreed to its use.

Clause 4 (A) – Compliance with the features and guidance set-out in Sewerage Sector Guidance, as modified by UU's Addendum, will be deemed to provide a reliable and efficient design.

Clause 5 (A) – Provision of a system utilising a potable water supply is acceptable to avoid septicity.

### **D7.2 Hazardous areas**

Clause 3 (R) – Every pumping station installation, including its wet well and valve chamber, shall be assessed and classified in accordance with UU’s model risk assessment technique contained in UU’s Code of Practice “Installations in Potentially Explosive Atmospheres associated with Water & Wastewater (Document ref 60024)”.

### **D7.3 Wet Well – General**

Clause 1 (A) – The hydraulic design of the wet well shall be based on previously used successful designs and recognised guidance such as that available from BHRG or the Hydraulic Institute. Unconventional layouts shall not be proposed unless they include wet well modelling as a part of the proposal. Wet wells shall include flow control baffles, plates and benching, as necessary, to achieve the requirements set out in the following clauses.

Clause 5.b (A) – The maximum acceptable pre-swirl angle is 5 degrees.

Clause 5.c (D) – Clause to be deleted.

**Note:** Reason for deletion: provided that the wet well has been designed as detailed in the preceding clauses and the pump unit is capable of running in ‘snore’ mode, then the requirements of 5c are already satisfied.

### **D7.4 Wet Well – Structural Design**

Clause 2 (R) – Design to counter flotation shall be carried out using the method in BS EN 1997-1.

Clause 3 (R) – Precast concrete units shall conform to BS EN 1917 and BS 5911-3. Joints between precast units shall be watertight as defined in Clause E7.8. The wet well shall be surrounded with not less than 150 mm thickness of GEN3 concrete.

Clause 4 (R) – If constructed of in situ concrete the wet well shall be designed to BS EN 1992-3 tightness class 1. Cover slabs shall either be precast units conforming to BS EN 1917 and BS 5911-3 or in situ concrete designed in accordance with BS EN 1992-1 with an applied loading of accidental wheel load. The concrete mix and cover to reinforcement shall be determined from BS 8500. These parameters will depend on the aggressiveness of the ground which shall be determined using BRE Special Digest 1.

Clause 7 (A) – If the use of polyethylene and glass reinforced plastics (GRP) mouldings for package pumping stations applications is proposed, prior approval shall be obtained from UU. Mouldings shall incorporate all necessary inlet and outlet connections and preformed benching of the bottom section to prevent debris accumulating in dead

zones. In addition, for increased depths or non-standard site conditions, increased wall thicknesses shall be used in conjunction with the inclusion of external reinforcing ribs around the circumference of the moulding.

Clause 8 (A) – The base of the tank shall be flat or incorporate either stabilising feet or a circular base ring to enable the tank to be positioned on a RC slab at the bottom of the excavation. The pumping station shell moulding shall incorporate an anti-flotation skirt to enable wet concrete, when poured around the station, to flow into the skirt as a mechanical key to offset the effects of buoyancy.

- The requirements for the foundation slab and backfilling shall be as directed in the manufacturer’s technical guidance literature. In locations subject to high water tables, the designer shall ensure that all necessary measures have been implemented to prevent flotation of the tank under all operating conditions. The uplift force can be considerable particularly if the water table reaches up to ground level. Anti-flotation requirements and minimum GRP thickness shall be calculated to ensure the pumping station can resist these forces.

### **D7.5 Valve chamber**

Clause 1 (A) – The structural design of the valve chamber shall be as the wet well.

Clause 4 (R) – The valve chamber shall be provided with gravity drain pipework to return leakage, rainwater etc. into the wet well. The inlet end of the drain pipe, in the valve chamber, shall be fitted with a non-return valve to limit the possibility of crude sewage passing directly from the wet well into the valve chamber. This arrangement shall be considered as an integral part of the DSEAR risk assessment as required by clause D7.2 clause 3.

### **D7.6 Flow metering**

Clause 1 (R) – For Type 3 pumping stations where the pump design flow rate of any pump unit is greater or equal to 70 litres per second, a flowmeter shall be provided in the valve chamber or in a separate chamber to monitor discharge performance.

Clause 2 c) (A) – Where it is not practicable to drain back into the wet well the flow meter chamber shall have a water tight cover.

### **D7.7 Access into Wet Well, Valve Chambers and Flow meter Chambers**

Clause 7 (A) – Access to electrical equipment in the wet well shall be by means of local isolation points at the surface to the well and be designed such that an operator does not have to enter the well to pull cables for pumps or instrumentation.

### **D7.8 Cable Ducts**

Clause 2 (A) – All cable ducts passing between the wet well or valve chamber to the kiosk (or other control panel building) shall be sealed using a gas-tight sealing technique (not foam).

### **D7.10 Kiosk**

Clause 1 (R) – The kiosk shall, as a minimum, enclose the following equipment:

- a) The electrical assembly.
- b) A combined type 1 and type 2 electrical surge suppression unit to protect the complete electrical installation, complete with indication of unit failure.
- c) The telemetry outstation (normally UU installations to have an outstation as part of the ICA Section).
- d) A kiosk heating and lighting system.
- e) A RCD switched 230V socket.
- f) A kiosk fire detector.
- g) Cable support details and containment trunking.

Clause 2 (A) – The kiosk layout shall be set out as detailed on the drawing in this addendum.

### **D7.11 Kiosk construction**

Clause 2 (A) – Where steel kiosks are provided, the kiosk shall be fitted with internal insulation to limit the effects of external temperatures during the seasons and prevent the build-up of condensation which would affect the controls.

Clause 12 (R) – The kiosk shall be arranged for either a separate compartment to the main kiosk or be of sufficient size to allow the DNO's supply and meter to be installed, The latter shall be used where there is a problem with cross ventilation in the kiosk.

Clause 14 (R) – The kiosk doors shall be fitted with an Abloy manufactured key-barrelled lock.

### **Figure D4**

#### **Section A-A**

Replace the note “Benching 60° minimum slope” by “Benching preferred to be 60°, but to be a minimum 45° slope”.

#### **Plan View**

In the Plan View, the valve chamber drainage pipework shall extend, including a rocker pipe and couplings, into the wet well to enable positive drainage i.e. the sketch shall not be interpreted as a ‘soak-away’ system.

Location of the cable entry into the wet well to be modified in line with standard UU requirements to incorporate a junction box just outside of the wet well (the current design would need operators to enter the well to pull cables). The design shall minimize H&S issues for the operations team.



## Part F – Mechanical and Electrical Specification for Small Pumping Stations

### F1 GENERAL

#### F1.1 Hazardous area appliances

Clause 1 (R) – The risk assessment shall be carried out referencing the guidelines included in the UU Code of Practice “Installations in Potential Explosive Atmospheres Associated with Water and Wastewater” and shall comply with DSEAR and UU H&S Procedure “Dangerous Substances and Explosive Atmosphere Regulations”.

#### F1.2 Operation and maintenance documentation

Clause 1 (R) – Two hard copies and three electronic copies are required.

### F2 PUMP UNIT SPECIFICATION

#### F2.2 Performance Requirements and Information

Clause 3 (The second sentence shall not apply) – Reason: practically speaking, vibration will always be present when the pump unit is running and cavitation will often be present, especially when the NPSH margin is low. What is vital is that neither the vibration, nor the cavitation, will reach levels that will cause damage that will shorten the pump unit’s design life when operated in the proposed design configuration. Other clauses within the specification address these issues.

Clause 4 (R) – Deterioration of all elements of the pumping system is to be expected with time. This shall be catered for by using a conservative ks factor for the rising main roughness (refer to clause D6.3 clause 2) and by including a +10% power margin in the pump unit motor power available.

Clause 5 (D) – The following wording in this clause shall not apply: “to keep the wet well free from silt”. Reason: the wet well is unlikely to ever be completely free from silt and it is the hydraulic & benching design that will minimise the amount of residual silt, which is specified in clause D7.3.

Clause 8 (R) – The pump units shall be capable of discharging into an empty rising main. Reason: for low specific speed pumps, which naturally have an overloading power curve, the requirement to be able to discharge into an empty main is an onerous duty that could lead to an unnecessarily high powered motor being fitted. For a true rising main, it is never necessary in normal operation (only during commissioning under hand control via the isolating valve). This requirement should therefore only be invoked when it is actually necessary.

Clause 9 (A) – Where this would lead to overheating of the pump contents or if this operating condition would lead to the pump separating from the auto-coupling system due to the pump closed valve discharge head, the developer shall inform the Undertaker of this non-compliance along

with a proposed solution to allow safe operation of each pump unit in accordance with the pump manufacturer’s recommendations.

Clause 10 (Delete wording) – The wording in parentheses, within the ‘Note’ section of this clause, shall not apply.

Clause 11 (Delete sentence) – The first sentence of this clause shall not apply.

#### F2.3.3 Noise

Clause 1 (R) – The developers make themselves aware of any Planning Authority restriction on noise levels from the site and shall ensure that any contributory noise emanating from the pump units is taken into account in satisfying the planning constraints.

#### F2.3.5 Pump casings

Clause 3 (A) – Where pumps are not available that include renewable casing wear plates, the developer shall inform UU of this non-compliance along with a proposed solution for agreement.

#### F2.3.6 Impellers

Clause 6 (A) – Where pumps are not available that include renewable impeller wear rings, the developer shall inform UU of this non-compliance along with a proposed solution for agreement.

#### F2.3.9 Bearings and bearing lubrication

Clause 2 (R) – Pump unit bearings shall be designed for a six year life, taking into account the actual utilisation factor or expected running hours of the pump unit being proposed. Where pump units are not available that include compliant bearings, the developer shall inform UU of this non-compliance along with a proposed solution for agreement.

#### F2.3.16 Pump Unit Protection Sensors

Clause 2 – (Delete wording) - Delete the words “wear and seal”.

Clause 3 – (Delete sentence) - The requirements of clause 3 shall not apply.

Clause 4 – (Delete sentences) - The requirements of clause 4 shall not apply.



## **F2.4 Testing**

### **F2.4.1 General**

Clause 1 (R) – Each pump unit shall be assembled and tested to comply with its design intentions and the project specific performance requirements. Vibration testing and acceptance shall be in accordance with BS ISO 10816 -7. Hydraulic performance shall be tested to BS EN ISO 9906 Grade 2 Annex A as a minimum, or where a higher grade is required (e.g. minimum pass forward flow to be achieved under all circumstances), the hydraulic acceptance test code and tolerances shall be agreed with UU. Type test certificates will be acceptable and shall be included in the pump unit Operating and Maintenance manuals. Acceptance of the pump units' performance is also subject to acceptable Site Testing.

### **F2.4.2 Testing on site**

Clause 1 (R) – Each pump unit shall be tested at site to ensure it is capable of transferring at least the specified flow rate, with the specified working level range in the wet well.

Clause 3 (R) – A visual inspection of the pumping station shall be made in the presence of UU, as a part of the Site Tests, to ensure that the visible components, layout and hydraulic performance comply with the General Arrangement drawings and the design intentions. Functional checks shall be made of all installed instrumentation, level settings, control systems and equipment protection devices. Where any components or features are missing or malfunction, or the visible performance of the wet well is non-compliant (including dead zones, excessive vorticity or solids accumulations), the developer shall investigate the deficiency and rectify it to the satisfaction of UU.

## **F3 ELECTRICAL**

### **F3.3.4 Earthing and Bonding**

#### **F3.3.4.1 General**

Clause 1 (A) – The earthing arrangement shall include an earth bar within the kiosk arranged for the DNO earth, equipment earth and facility for a generator earth with a disconnection link to ensure no earth onto the DNO's earth system in the event of a generator being connected.

Clause 5 (R) – The plant earth bar shall be installed in the kiosk.

### **F3.3.5.4 Termination of wiring**

#### **F3.3.5.4.1 General**

Clause 9 (A) – The design shall include for a means of local isolation for electrical cables without the need for operational personnel to enter the wet well by means of a harness or leaning into the wet well.

### **F3.3.7 Connection for a mobile generator**

Clause 1 (R) – For Type 3 pumping stations, a connection for a mobile generator shall be provided as a separate unit of the electrical assembly. This shall be a 125A, 5 pole (L1, L2, L3 + N + E), male appliance inlet to BS EN 60309-2. This shall provide separate feeders for the electrical assembly and the kiosk distribution board.

### **F3.3.8 Abnormal Operation**

#### **F3.3.8.3 Interruption/loss of ultrasonic signal**

Clause 3 (A) – The control system shall be arranged such that in the event of the high level instrument operating back up control shall be initiated.

#### **F3.3.8.5 (R) – Wet Well Level Monitoring**

Clause 1 (R) – Change from High-High to Persistent High Level.

Clause 2 (A) – Spill monitoring to be initiated if the Persistent High level is instigated for a set period of time as agreed with UU.

### **F3.3.9 Telemetry Signals**

Clause 4 (A) A block set of volt free terminals shall be provided for future use to telemetry. These signals shall be:

- Pump running (for each pump)
- Pump available (failsafe, for each pump)
- Pump in auto (for each pump)
- Site mains DNO power healthy (failsafe)
- Level controller healthy (failsafe)
- High wet well alarm (failsafe)
- Kwhr pulse (when applicable)
- Wet Well Spill (when applicable)
- Wet well effluent level (to be provided as a 4 – 20mA signal)

**Table F3 – Modify and Add signals**

3rd row (R) – change function from High-high to Persistent High Level

Add – Wet Well Spill.

**F3.3.10 – Ultrasonic Level Controller (ULC) Specification**

General (A) – A proprietary controller can be provided for the control of the pumps utilising a separate ultrasonic level measurement and backup level device. The controller provided can incorporate a communications module (WITS compatibility) suitable for connecting to UU's Alarm and Monitoring Centre (AMC), which would reduce the need for telemetry terminations and a separate telemetry outstation.

**F3.3.10.3 Functionality**

Clause 2 (A) – e) power monitoring

**F3.3.11 Functional Units – Form 4 assemblies****F3.3.11.2 Incomer compartment**

Clause 3 a) (R) – Two 4 pole (3- phase and switched neutral) fuse switches with suitably-rated HRC fuses, mechanically interlocked and assembled to form a switch for the mains and mobile generator supplies. This shall be provided as a separate unit to the form 4 assembly. The switch shall be labelled “Mains/Off/Generator”.

Clause 3 d) (A) – The arrangement of the distribution board installation shall ensure that kiosk services are available if the electrical assembly is isolated for any reason. The design shall take into account the need of operations carrying out activities in the control panel and needing building services in the kiosk.

**F3.3.11.4 Motor starter compartments**

Clause 5 (A) – Details of individual alarms required for each starter shall be agreed with UU.

**F3.3.11.5 Common control compartment**

Clause 1 f) (A) – Separate indication is required for high level and persistent high level.

Clause 1 g) (A) – A separate spill monitoring alarm to be provided on the door and transmitted to telemetry.

**F3.3.12 Functional Units – Form 2 assemblies****F3.3.12.3 Incomer**

Clause 3 d) (A) – The arrangement of the distribution board installation shall ensure that kiosk services are available if the electrical assembly is isolated for any reason. The design shall take into account the need of operations carrying out activities in the control panel and needing building services in the kiosk.

**F3.3.12.5 Motor starters**

Clause 8 (A) – Details of individual alarms required for each starter shall be agreed with UU.

Clause 9 (A) – The panel shall be arranged such that each starter circuit can be locked off.

**F3.3.12.6 Common control compartment**

Clause 1 e) (A) – Separate indication is required for high level and persistent high level.

Clause 1 g) (A) – Separate spill monitoring alarm to be provided on the door and transmitted to telemetry.

**F3.4.1.5 Junction boxes**

Clause 3 (A) – Local isolation point junction boxes (JBs) shall be designed for ease of access by operations and cable entry suitable for the orientation of the JB.

Clause 6 (A) – Cable glands for JB's shall be suitable for the environment and be fitted with IP washers.

Clause 7 (A) – JB's installed in the installation shall be suitably rated to prevent ingress of moisture during normal operation and in the event of them being submersed.

**F3.4.4 Installation of cables**

Clause 5 a) (A) – The DNO cable duct shall be coloured RED.

Clause 5 c) (R) – Pump unit cables – two 100 mm diameter ducts shall be provided and routed between the kiosk and the local isolation point.

Clause 5 d) (R) – the ultrasonic and digital level switch cables. – one 100 mm diameter duct shall be provided routed between the kiosk and local isolation point.

Clause 5 g) (A) – Earthing and bonding of electrical equipment shall be carried out using earthing cables routed through the appropriate cable duct.

Clause 8 (R) – The pump and instrument cables shall be routed from the local isolation JB's at high level in the wet well (see UU standard arrangement) to allow for the isolation of cables without the need for entering the wet well on a harness or leaning into the wet well or having to pull cables through ducts to the local isolation JB.

**F3.4.6 Earthing and Bonding****F3.4.6.1 General**

Clause 5 (R) – A removable link shall be provided to disconnect the pumping station from the DNO's main earth terminal (MET) and connect it to the earth electrode (see F3.4.6.2), in the event that a mobile generator is connected to the pumping station (separate requirement to F3.4.6.2.1.2).

**F3.4.6.2. Earth electrode**

Clause 1 (R) – The earth electrode system shall be designed in accordance with the current British Standard and calculation of the earth electrode design provided as part of the review information.

Clause 2 (A) – The earth electrode shall be connected to the DNO's main earth terminal (MET) via a removable test link.

Clause 3 (A) – An earth bar terminal shall be provided for the connection of the mobile generator star point to the earth electrode. A label shall be fixed adjacent to the terminal stating "Bolted Earth Connection Shall Be Made Before the Generator Is Connected With the Main Plug And Socket".

**F3.4.6.3. Bonding****F3.4.6.3.3 Supplementary equipotential bonding****Figure F.3**

Clause 5 (A) – The earthing and bonding cables shall be connected to the earth bar in the kiosk and shall be routed to the relevant equipment or structures through cable ducts provided from the kiosk to the specific area of the installation.

**F3.5 Instrumentation**

A) General installation of instruments shall be arranged to allow for good access for maintenance or removal without causing any operational or H&S issues for the operator.

**F4 Valve specification****F4.1 Gate (sluice) valves**

Clause 2 (A) – All gate valves shall be operable whilst standing at local ground level.

**F4.2 Check (reflux) valves**

Clause 2 (R) – All non-return valves shall be selected and installed to suit the operational environment including being matched to the calculated surge conditions.

One complete working sets of operating instruction/ maintenance manuals shall be provided. These manuals shall be in separate folders bound in loose-leaf volumes and be clearly indexed. A further four copies of the O&M manual are also required on four separate CDs.

All items shall be A4 or A3 size.

The manuals shall include the following:

1. Index and references
2. Details of plant.
3. Schedule of drawings and wiring diagrams including general arrangement drawing.
4. Maintenance instructions for all items.
5. Fault finding and rectification instructions.
6. Operating instructions.
7. Spare parts list for all items.
8. Performance curves
9. Test certificates.
10. 'Ex' Certificates and schedule – including hazardous area zoning report / drawing as required by DSEAR regulations.
11. Results of all on site tests.
12. Results of all off site tests.
13. Commissioning test results tabulated and certified.
14. PLC back-up disk, if applicable.

In addition to the above, the following items will be required at the time of adoption:



1. NICEIC completion and test certificates together with any subsequent inspection reports.
2. Maintenance records will be required at the time of adoption in particular for repairs and maintenance of certified equipment. Records shall also contain a complete event log and meter readings. Failure to provide records may lead to additional costs for Developers
3. H&S file – One complete hard copy shall be provided with five copies on CD.

It is important that all items of EX certified equipment are installed and maintained in accordance with BS EN60079. Only Contractors trained to maintain and install certified equipment shall be permitted to do so.

**Note:** A collection of Manufacturer's leaflets will not be accepted in place of a manual. ATEX is the name commonly given to the legal requirements for controlling explosive atmospheres and the suitability of equipment and protective systems used in them. DSEAR states the legal requirements for managing the risk of fire, explosion or similar events arising from dangerous substances at the workplace.

1	2	3	4	5	6	7	8
UU DRAWING NUMBER	DOCUMENT TITLE	COMP. REF.	No. of SHEETS	LME DWG. No.	REV.		
-	DRAWING REGISTER		1 of 1	TEMPLATE-000	P01		
-	UU DESIGN BUILD INFORMATION SHEET		1 of 1	TEMPLATE-001	P01		
-	GENERAL ARRANGEMENT		1 of 1	TEMPLATE-002	P01		
-	DOOR LAYOUT - TIER 1		1 of 1	TEMPLATE-003	P01		
-	DOOR LAYOUT - TIER 2		1 of 1	TEMPLATE-004	P01		
-	-		-	-	-		
-	PUMP No.1	1A	1 of 2	TEMPLATE-010	P01		
-	PUMP No.1	1A	2 of 2	TEMPLATE-011	P01		
-	PUMP No.2	1B	1 of 2	TEMPLATE-012	P01		
-	PUMP No.2	1B	2 of 2	TEMPLATE-013	P01		
-	MAINS INCOVER, METERS & COMMON CONTROL SECTION	1C	1 of 1	TEMPLATE-014	P01		
-	ICA SECTION	2A	1 of 7	TEMPLATE-015	P01		
-	ICA SECTION	2A	2 of 7	TEMPLATE-016	P01		
-	ICA SECTION	2A	3 of 7	TEMPLATE-017	P01		
-	ICA SECTION	2A	4 of 7	TEMPLATE-018	P01		
-	ICA SECTION	2A	5 of 7	TEMPLATE-019	P01		
-	ICA SECTION	2A	6 of 7	TEMPLATE-020	P01		
-	ICA SECTION	2A	7 of 7	TEMPLATE-021	P01		

		LLOYD MORRIS ELECTRICAL LTD Factory Business Centre Worsley North West LL1 2UD TEL: 0161 275 1505 E: lme@lloyd-morris.co.uk
THE DRAWING IS PROVIDED AS INFORMATION. IT IS SUBJECT TO THE AGREED CONDITIONS AND IS NOT TO BE USED OR COMMUNICATED TO OTHER PARTIES WITHOUT THE WRITTEN PERMISSION OF LLOYD MORRIS ELECTRICAL LTD		
ISSUED BY:	CP01	
ISSUE NO.	TEMPLATE-000	
CURRENT ISSUE INFORMATION		
ISSUE NO.	ISSUE DATE	ISSUE DESCRIPTION
P01	05/12/19	FOR GUIDANCE ONLY
S4		FOR TECHNICAL REVIEW
 Water for the North West		
UU SEWERAGE SECTOR DAC GUIDANCE APPENDIX C ADDENDUM TYPICAL PUMPING STATION CONTROL PANEL CP01 DRAWING REGISTER		
DATE	BY	CHKD BY
N.T.S		P01
PROJECT CODE	TBA	

© The copyright of this document, which contains information of a proprietary nature, is vested in United Utilities Water PLC. The content of this document may not be used for purposes other than that for which it has been supplied and may not be reproduced, either wholly or in part, in any way whatsoever. It may not be used by, or its contents divulged to any other person whatsoever without the prior written permission of United Utilities Water PLC. Copyright Acknowledgement: Use of Ordnance Survey map data sanctioned by the controller of H.M. Stationery Office. OS Licence Number: 100019026. Crown copyright reserved. Unauthorised production infringes copyright.

<p><b>CONTRACT DETAILS</b></p> <p><u>SPECIFIC INFORMATION</u></p> <table border="1" style="width:100%; border-collapse: collapse;"> <tr> <td style="width:50%;">CUSTOMER</td> <td style="width:50%;">-</td> </tr> <tr> <td>CUSTOMER REFERENCE</td> <td>-</td> </tr> <tr> <td>SITE LOCATION</td> <td>PS</td> </tr> <tr> <td>STANDARD SPECIFICATION</td> <td>E101 ADOPTING WIMES 3.01 S04</td> </tr> <tr> <td>INTERIOR MAPS</td> <td>YES <input checked="" type="checkbox"/> NO <input type="checkbox"/></td> </tr> <tr> <td>TERMINAL RAIL DRAWINGS</td> <td>YES <input type="checkbox"/> NO <input checked="" type="checkbox"/></td> </tr> </table> <p><u>NOTES</u></p> <ol style="list-style-type: none"> <li>NON DEFEATABLE FUSES/WITCH HANDLES TO BE USED</li> <li>SPLIT BACKPLATES TO MOUNT FUSES/WITCHES ON STARTER DEVICES BELOW 250A</li> <li>INTERNAL PROFIBUS CABLING TO BE SEGREGATED FROM POWER</li> <li>INTERNAL CONTROL CABLING TO BE SEGREGATED FROM POWER WHERE REASONABLY PRACTICAL</li> <li>DISCONNECT TERMINALS TO BE USED FOR ANY TELEMETRY TERMINALS</li> <li>SHORTING TERMINALS TO BE USED FOR ANY CURRENT TRANSFORMER TERMINALS</li> <li>INTERNAL PROFIBUS DIAGRAM TO BE USED FOR NETWORK AND CABLING IDENTIFICATION</li> <li>VSD HIGH FREQUENCY EARTH BRADING AND PROTECTIVE EARTHING SYSTEM REQUIRED</li> <li>METALIC PROFIBUS FAST CONNECT TERMINATORS FOR PROFIBUS COMMUNICATION WIRING SHALL BE USED.</li> <li>400V DANGER LABEL REQUIRED ON INCOMER COMPARTMENT ONLY</li> <li>AMBIENT TEMPERATURE OF THE M.C.C. MUST NOT EXCEED 35°C</li> </ol>	CUSTOMER	-	CUSTOMER REFERENCE	-	SITE LOCATION	PS	STANDARD SPECIFICATION	E101 ADOPTING WIMES 3.01 S04	INTERIOR MAPS	YES <input checked="" type="checkbox"/> NO <input type="checkbox"/>	TERMINAL RAIL DRAWINGS	YES <input type="checkbox"/> NO <input checked="" type="checkbox"/>	<p><b>PROJECT DETAILS</b></p> <p><u>CABLING COLOUR SCHEME</u></p> <table border="1" style="width:100%; border-collapse: collapse;"> <tr> <td style="width:50%;">CABLE/WIRE</td> <td style="width:50%;">SHEATH COLOUR</td> </tr> <tr> <td>PROTECTIVE CONDUCTOR</td> <td>GREEN/YELLOW</td> </tr> <tr> <td>POWER CIRCUITS</td> <td></td> </tr> <tr> <td>  PHASE 1 L1</td> <td>BROWN</td> </tr> <tr> <td>  PHASE 2 L2</td> <td>BLACK</td> </tr> <tr> <td>  PHASE 3 L3</td> <td>GREY</td> </tr> <tr> <td>  NEUTRAL N</td> <td>BLUE</td> </tr> <tr> <td>CONTROL CIRCUITS</td> <td></td> </tr> <tr> <td>  230Vac L</td> <td>BROWN</td> </tr> <tr> <td>  230Vac N</td> <td>BLUE</td> </tr> <tr> <td>  110Vac L</td> <td>RED</td> </tr> <tr> <td>  110Vac N</td> <td>BLUE</td> </tr> <tr> <td>  30Vac L</td> <td>YELLOW</td> </tr> <tr> <td>  24Vac L</td> <td>YELLOW</td> </tr> <tr> <td>  0Vdc N</td> <td>BLUE</td> </tr> <tr> <td>TELEMETRY</td> <td>PINK</td> </tr> <tr> <td>INTRINSICALLY SAFE (TO BE SEGREGATED)</td> <td>LIGHT BLUE</td> </tr> <tr> <td>ANALOGUE SCREENED SINGLE CORE -IVE</td> <td>BLACK</td> </tr> <tr> <td>  SINGLE CORE -IVE</td> <td>WHITE</td> </tr> <tr> <td>  SINGLE CORE -IVE</td> <td>BLUE</td> </tr> <tr> <td>IO MULTICORE SINGLE CORES</td> <td>GREY</td> </tr> <tr> <td>  MULTI COLOUR</td> <td>MULTI COLOUR</td> </tr> <tr> <td>CURRENT TRANSFORMERS</td> <td>BLACK</td> </tr> <tr> <td>  PROFIBUS DP SCREENED</td> <td>PURPLE</td> </tr> <tr> <td>  PROFIBUS PA (NON IS)</td> <td>ORANGE</td> </tr> <tr> <td>  PROFIBUS PA (IS)</td> <td>LIGHT BLUE</td> </tr> <tr> <td>  SINGLE CORES</td> <td>RED/GREEN</td> </tr> <tr> <td>EXTRUDER VOLTAGE KNOW VOLTAGE</td> <td>RED</td> </tr> <tr> <td>  BASED ON VOLTAGE</td> <td>BASED ON VOLTAGE</td> </tr> <tr> <td>ANALOGUE 4-20mA AND 1-5Vdc</td> <td>VIOLET</td> </tr> </table> <p><u>CONTROL SWITCHES &amp; PUSHBUTTON COLOUR SCHEME</u></p> <table border="1" style="width:100%; border-collapse: collapse;"> <tr> <td style="width:50%;">DEVICE FUNCTION</td> <td style="width:50%;">COLOUR</td> </tr> <tr> <td>START</td> <td>GREEN</td> </tr> <tr> <td>STOP</td> <td>RED</td> </tr> <tr> <td>RESET</td> <td>BLACK</td> </tr> <tr> <td>EMERGENCY STOP</td> <td>RED</td> </tr> <tr> <td>INCH</td> <td>GREEN</td> </tr> <tr> <td>LAMP TEST</td> <td>YELLOW</td> </tr> <tr> <td>FUNCTION TEST</td> <td>YELLOW</td> </tr> <tr> <td>CLOSE</td> <td>GREEN OR BLACK</td> </tr> <tr> <td>OPEN</td> <td>RED</td> </tr> </table> <p><u>INDICATING LAMP COLOUR SCHEME</u></p> <table border="1" style="width:100%; border-collapse: collapse;"> <tr> <td style="width:50%;">DEVICE FUNCTION</td> <td style="width:50%;">COLOUR</td> </tr> <tr> <td>AVAILABLE / AUTO-AVAILABLE</td> <td>WHITE</td> </tr> <tr> <td>SUPPLY ON</td> <td>WHITE</td> </tr> <tr> <td>RUNNING</td> <td>RED</td> </tr> <tr> <td>STOPPED</td> <td>GREEN</td> </tr> <tr> <td>EMERGENCY STOP</td> <td>YELLOW/AMBER</td> </tr> <tr> <td>DAINGEROUS CONDITION</td> <td>RED</td> </tr> <tr> <td>NORMAL CONDITION</td> <td>WHITE</td> </tr> <tr> <td>ALARM</td> <td>YELLOW / AMBER</td> </tr> <tr> <td>TRIPPED / FAULT</td> <td>YELLOW / AMBER</td> </tr> <tr> <td>ON</td> <td>RED</td> </tr> <tr> <td>OFF</td> <td>GREEN</td> </tr> <tr> <td>PROCESS INDICATORS</td> <td>YELLOW / AMBER</td> </tr> </table> <p><u>TERMINAL RAIL</u></p> <table border="1" style="width:100%; border-collapse: collapse;"> <tr> <td style="width:50%;">DESCRIPTION</td> <td style="width:50%;">-X REF</td> </tr> <tr> <td>400Vdc AND MOTOR PROTECTION</td> <td>-X1</td> </tr> <tr> <td>110Vac</td> <td>-X2</td> </tr> <tr> <td>24Vac and 30Vac</td> <td>-X3</td> </tr> <tr> <td>INSTRUMENTATION</td> <td>-X4</td> </tr> <tr> <td>TELEMETRY</td> <td>-X5</td> </tr> <tr> <td>CURRENT TRANSFORMERS</td> <td>-X6</td> </tr> </table>	CABLE/WIRE	SHEATH COLOUR	PROTECTIVE CONDUCTOR	GREEN/YELLOW	POWER CIRCUITS		PHASE 1 L1	BROWN	PHASE 2 L2	BLACK	PHASE 3 L3	GREY	NEUTRAL N	BLUE	CONTROL CIRCUITS		230Vac L	BROWN	230Vac N	BLUE	110Vac L	RED	110Vac N	BLUE	30Vac L	YELLOW	24Vac L	YELLOW	0Vdc N	BLUE	TELEMETRY	PINK	INTRINSICALLY SAFE (TO BE SEGREGATED)	LIGHT BLUE	ANALOGUE SCREENED SINGLE CORE -IVE	BLACK	SINGLE CORE -IVE	WHITE	SINGLE CORE -IVE	BLUE	IO MULTICORE SINGLE CORES	GREY	MULTI COLOUR	MULTI COLOUR	CURRENT TRANSFORMERS	BLACK	PROFIBUS DP SCREENED	PURPLE	PROFIBUS PA (NON IS)	ORANGE	PROFIBUS PA (IS)	LIGHT BLUE	SINGLE CORES	RED/GREEN	EXTRUDER VOLTAGE KNOW VOLTAGE	RED	BASED ON VOLTAGE	BASED ON VOLTAGE	ANALOGUE 4-20mA AND 1-5Vdc	VIOLET	DEVICE FUNCTION	COLOUR	START	GREEN	STOP	RED	RESET	BLACK	EMERGENCY STOP	RED	INCH	GREEN	LAMP TEST	YELLOW	FUNCTION TEST	YELLOW	CLOSE	GREEN OR BLACK	OPEN	RED	DEVICE FUNCTION	COLOUR	AVAILABLE / AUTO-AVAILABLE	WHITE	SUPPLY ON	WHITE	RUNNING	RED	STOPPED	GREEN	EMERGENCY STOP	YELLOW/AMBER	DAINGEROUS CONDITION	RED	NORMAL CONDITION	WHITE	ALARM	YELLOW / AMBER	TRIPPED / FAULT	YELLOW / AMBER	ON	RED	OFF	GREEN	PROCESS INDICATORS	YELLOW / AMBER	DESCRIPTION	-X REF	400Vdc AND MOTOR PROTECTION	-X1	110Vac	-X2	24Vac and 30Vac	-X3	INSTRUMENTATION	-X4	TELEMETRY	-X5	CURRENT TRANSFORMERS	-X6	<p><b>CABLING</b></p> <p><u>ALPHABETICAL / NUMERIC CORE REFERENCING</u></p> <table border="1" style="width:100%; border-collapse: collapse;"> <tr> <th>ABBREVIATION</th> <th>DESCRIPTION</th> </tr> <tr> <td>(SCN)</td> <td>CABLE SCREEN</td> </tr> <tr> <td>(1,2,3) etc.</td> <td>CORE NUMBER OR CODE</td> </tr> <tr> <td>(BLK)</td> <td>PARTICULAR CORE COLOUR, EG. BLACK</td> </tr> <tr> <td>(BLU OR B)</td> <td>BLUE</td> </tr> <tr> <td>(BRN OR Bt)</td> <td>BROWN</td> </tr> <tr> <td>(GRN or G)</td> <td>GREEN</td> </tr> <tr> <td>(GRY or GY)</td> <td>GREY</td> </tr> <tr> <td>(O)</td> <td>ORANGE</td> </tr> <tr> <td>(PK)</td> <td>PINK</td> </tr> <tr> <td>(R)</td> <td>RED</td> </tr> <tr> <td>(Tu)</td> <td>TURQUOISE</td> </tr> <tr> <td>(V)</td> <td>VIOLET</td> </tr> <tr> <td>(WH or W)</td> <td>WHITE</td> </tr> <tr> <td>(YEL or Y)</td> <td>YELLOW</td> </tr> </table> <p><u>BUS BAR TO SWITCHGEAR MAX. CABLE LENGTHS</u></p> <table border="1" style="width:100%; border-collapse: collapse;"> <thead> <tr> <th>MAXIMUM LENGTH</th> <th>DEVICE RATING</th> <th>CABLE C.S.A.</th> </tr> </thead> <tbody> <tr> <td>1000mm</td> <td>32AMP</td> <td>6mm<sup>2</sup></td> </tr> <tr> <td>1000mm</td> <td>63AMP</td> <td>16mm<sup>2</sup></td> </tr> <tr> <td>1000mm</td> <td>100AMP</td> <td>35mm<sup>2</sup></td> </tr> <tr> <td>1000mm</td> <td>160AMP</td> <td>70mm<sup>2</sup></td> </tr> <tr> <td>1000mm</td> <td>200AMP</td> <td>95mm<sup>2</sup></td> </tr> <tr> <td>1000mm</td> <td>250AMP</td> <td>120mm<sup>2</sup></td> </tr> <tr> <td>1000mm</td> <td>315AMP</td> <td>150mm<sup>2</sup></td> </tr> </tbody> </table> <p><u>POWER EARTHING MINIMUM CABLE SIZE</u></p> <table border="1" style="width:100%; border-collapse: collapse;"> <thead> <tr> <th>BSSB FUSE RATING</th> <th>MINIMUM EARTH CABLE C.S.A.</th> </tr> </thead> <tbody> <tr> <td>32AMP</td> <td>6mm<sup>2</sup></td> </tr> <tr> <td>63AMP</td> <td>6mm<sup>2</sup></td> </tr> <tr> <td>100AMP</td> <td>10mm<sup>2</sup></td> </tr> <tr> <td>160AMP</td> <td>16mm<sup>2</sup></td> </tr> <tr> <td>200AMP</td> <td>25mm<sup>2</sup></td> </tr> <tr> <td>250AMP</td> <td>35mm<sup>2</sup></td> </tr> <tr> <td>315AMP</td> <td>50mm<sup>2</sup></td> </tr> <tr> <td>400AMP</td> <td>50mm<sup>2</sup></td> </tr> </tbody> </table> <p>RATING ABOVE IS BASED ON CABLES INSTALLED INFREE AIR AND NOT WITHIN TRUNKING.</p>	ABBREVIATION	DESCRIPTION	(SCN)	CABLE SCREEN	(1,2,3) etc.	CORE NUMBER OR CODE	(BLK)	PARTICULAR CORE COLOUR, EG. BLACK	(BLU OR B)	BLUE	(BRN OR Bt)	BROWN	(GRN or G)	GREEN	(GRY or GY)	GREY	(O)	ORANGE	(PK)	PINK	(R)	RED	(Tu)	TURQUOISE	(V)	VIOLET	(WH or W)	WHITE	(YEL or Y)	YELLOW	MAXIMUM LENGTH	DEVICE RATING	CABLE C.S.A.	1000mm	32AMP	6mm <sup>2</sup>	1000mm	63AMP	16mm <sup>2</sup>	1000mm	100AMP	35mm <sup>2</sup>	1000mm	160AMP	70mm <sup>2</sup>	1000mm	200AMP	95mm <sup>2</sup>	1000mm	250AMP	120mm <sup>2</sup>	1000mm	315AMP	150mm <sup>2</sup>	BSSB FUSE RATING	MINIMUM EARTH CABLE C.S.A.	32AMP	6mm <sup>2</sup>	63AMP	6mm <sup>2</sup>	100AMP	10mm <sup>2</sup>	160AMP	16mm <sup>2</sup>	200AMP	25mm <sup>2</sup>	250AMP	35mm <sup>2</sup>	315AMP	50mm <sup>2</sup>	400AMP	50mm <sup>2</sup>	<p><b>GENERAL</b></p> <p><u>LINE-TYPES FOR EQUIPMENT &amp; CONDUCTORS</u></p> <p>----- LOCATED WITHIN M.C.C. OR PANEL</p> <p>----- INCOMING / OUTGOING OR BETWEEN M.C.C. OR PANEL SUB-COMPARTMENTS (ALSO INDICATIVE OF CABLE SCREENS)</p> <p>----- LOCATED EXTERNAL TO M.C.C. OR PANEL</p> <p>----- EARTH (PE) IS SHOWN AS DOTTED FOR IDENTIFICATION BUT THIS IS INTERNAL TO THE M.C.C.</p> <p><u>TERMINATION</u></p> <p>EXAMPLE:</p> <p>TERMINAL No. TO BE THE SAME AS THE WIRE No.</p> <p><u>FORMAT FOR REFERENCING RELAY CONTACTS</u></p> <p>EXAMPLE:</p> <p>DRAWING No. / COLUMN REF.</p> <p><u>FORMAT FOR INTERCONNECTING CABLING</u></p> <p>EXAMPLE:</p> <p>WIRE IS TO BE IDENTIFIED THE SAME AT BOTH ENDS</p> <p><u>FORMAT FOR INPUTS/OUTPUTS CABLING</u></p> <p>EXAMPLE:</p> <p>WIRE IS TO BE IDENTIFIED THE SAME AT BOTH ENDS</p>
CUSTOMER	-																																																																																																																																																																																																														
CUSTOMER REFERENCE	-																																																																																																																																																																																																														
SITE LOCATION	PS																																																																																																																																																																																																														
STANDARD SPECIFICATION	E101 ADOPTING WIMES 3.01 S04																																																																																																																																																																																																														
INTERIOR MAPS	YES <input checked="" type="checkbox"/> NO <input type="checkbox"/>																																																																																																																																																																																																														
TERMINAL RAIL DRAWINGS	YES <input type="checkbox"/> NO <input checked="" type="checkbox"/>																																																																																																																																																																																																														
CABLE/WIRE	SHEATH COLOUR																																																																																																																																																																																																														
PROTECTIVE CONDUCTOR	GREEN/YELLOW																																																																																																																																																																																																														
POWER CIRCUITS																																																																																																																																																																																																															
PHASE 1 L1	BROWN																																																																																																																																																																																																														
PHASE 2 L2	BLACK																																																																																																																																																																																																														
PHASE 3 L3	GREY																																																																																																																																																																																																														
NEUTRAL N	BLUE																																																																																																																																																																																																														
CONTROL CIRCUITS																																																																																																																																																																																																															
230Vac L	BROWN																																																																																																																																																																																																														
230Vac N	BLUE																																																																																																																																																																																																														
110Vac L	RED																																																																																																																																																																																																														
110Vac N	BLUE																																																																																																																																																																																																														
30Vac L	YELLOW																																																																																																																																																																																																														
24Vac L	YELLOW																																																																																																																																																																																																														
0Vdc N	BLUE																																																																																																																																																																																																														
TELEMETRY	PINK																																																																																																																																																																																																														
INTRINSICALLY SAFE (TO BE SEGREGATED)	LIGHT BLUE																																																																																																																																																																																																														
ANALOGUE SCREENED SINGLE CORE -IVE	BLACK																																																																																																																																																																																																														
SINGLE CORE -IVE	WHITE																																																																																																																																																																																																														
SINGLE CORE -IVE	BLUE																																																																																																																																																																																																														
IO MULTICORE SINGLE CORES	GREY																																																																																																																																																																																																														
MULTI COLOUR	MULTI COLOUR																																																																																																																																																																																																														
CURRENT TRANSFORMERS	BLACK																																																																																																																																																																																																														
PROFIBUS DP SCREENED	PURPLE																																																																																																																																																																																																														
PROFIBUS PA (NON IS)	ORANGE																																																																																																																																																																																																														
PROFIBUS PA (IS)	LIGHT BLUE																																																																																																																																																																																																														
SINGLE CORES	RED/GREEN																																																																																																																																																																																																														
EXTRUDER VOLTAGE KNOW VOLTAGE	RED																																																																																																																																																																																																														
BASED ON VOLTAGE	BASED ON VOLTAGE																																																																																																																																																																																																														
ANALOGUE 4-20mA AND 1-5Vdc	VIOLET																																																																																																																																																																																																														
DEVICE FUNCTION	COLOUR																																																																																																																																																																																																														
START	GREEN																																																																																																																																																																																																														
STOP	RED																																																																																																																																																																																																														
RESET	BLACK																																																																																																																																																																																																														
EMERGENCY STOP	RED																																																																																																																																																																																																														
INCH	GREEN																																																																																																																																																																																																														
LAMP TEST	YELLOW																																																																																																																																																																																																														
FUNCTION TEST	YELLOW																																																																																																																																																																																																														
CLOSE	GREEN OR BLACK																																																																																																																																																																																																														
OPEN	RED																																																																																																																																																																																																														
DEVICE FUNCTION	COLOUR																																																																																																																																																																																																														
AVAILABLE / AUTO-AVAILABLE	WHITE																																																																																																																																																																																																														
SUPPLY ON	WHITE																																																																																																																																																																																																														
RUNNING	RED																																																																																																																																																																																																														
STOPPED	GREEN																																																																																																																																																																																																														
EMERGENCY STOP	YELLOW/AMBER																																																																																																																																																																																																														
DAINGEROUS CONDITION	RED																																																																																																																																																																																																														
NORMAL CONDITION	WHITE																																																																																																																																																																																																														
ALARM	YELLOW / AMBER																																																																																																																																																																																																														
TRIPPED / FAULT	YELLOW / AMBER																																																																																																																																																																																																														
ON	RED																																																																																																																																																																																																														
OFF	GREEN																																																																																																																																																																																																														
PROCESS INDICATORS	YELLOW / AMBER																																																																																																																																																																																																														
DESCRIPTION	-X REF																																																																																																																																																																																																														
400Vdc AND MOTOR PROTECTION	-X1																																																																																																																																																																																																														
110Vac	-X2																																																																																																																																																																																																														
24Vac and 30Vac	-X3																																																																																																																																																																																																														
INSTRUMENTATION	-X4																																																																																																																																																																																																														
TELEMETRY	-X5																																																																																																																																																																																																														
CURRENT TRANSFORMERS	-X6																																																																																																																																																																																																														
ABBREVIATION	DESCRIPTION																																																																																																																																																																																																														
(SCN)	CABLE SCREEN																																																																																																																																																																																																														
(1,2,3) etc.	CORE NUMBER OR CODE																																																																																																																																																																																																														
(BLK)	PARTICULAR CORE COLOUR, EG. BLACK																																																																																																																																																																																																														
(BLU OR B)	BLUE																																																																																																																																																																																																														
(BRN OR Bt)	BROWN																																																																																																																																																																																																														
(GRN or G)	GREEN																																																																																																																																																																																																														
(GRY or GY)	GREY																																																																																																																																																																																																														
(O)	ORANGE																																																																																																																																																																																																														
(PK)	PINK																																																																																																																																																																																																														
(R)	RED																																																																																																																																																																																																														
(Tu)	TURQUOISE																																																																																																																																																																																																														
(V)	VIOLET																																																																																																																																																																																																														
(WH or W)	WHITE																																																																																																																																																																																																														
(YEL or Y)	YELLOW																																																																																																																																																																																																														
MAXIMUM LENGTH	DEVICE RATING	CABLE C.S.A.																																																																																																																																																																																																													
1000mm	32AMP	6mm <sup>2</sup>																																																																																																																																																																																																													
1000mm	63AMP	16mm <sup>2</sup>																																																																																																																																																																																																													
1000mm	100AMP	35mm <sup>2</sup>																																																																																																																																																																																																													
1000mm	160AMP	70mm <sup>2</sup>																																																																																																																																																																																																													
1000mm	200AMP	95mm <sup>2</sup>																																																																																																																																																																																																													
1000mm	250AMP	120mm <sup>2</sup>																																																																																																																																																																																																													
1000mm	315AMP	150mm <sup>2</sup>																																																																																																																																																																																																													
BSSB FUSE RATING	MINIMUM EARTH CABLE C.S.A.																																																																																																																																																																																																														
32AMP	6mm <sup>2</sup>																																																																																																																																																																																																														
63AMP	6mm <sup>2</sup>																																																																																																																																																																																																														
100AMP	10mm <sup>2</sup>																																																																																																																																																																																																														
160AMP	16mm <sup>2</sup>																																																																																																																																																																																																														
200AMP	25mm <sup>2</sup>																																																																																																																																																																																																														
250AMP	35mm <sup>2</sup>																																																																																																																																																																																																														
315AMP	50mm <sup>2</sup>																																																																																																																																																																																																														
400AMP	50mm <sup>2</sup>																																																																																																																																																																																																														

© The copyright of this document, which contains information of a proprietary nature, is vested in United Utilities Water PLC. The content of this document may not be used for purposes other than that for which it has been supplied and may not be reproduced, either wholly or in part, in any way whatsoever. It may not be used by, or its contents divulged to any other person whatsoever without the prior written permission of United Utilities Water PLC. Copyright Acknowledgement: Use of Ordnance Survey map data sanctioned by the controller of H.M. Stationery Office. OS Licence Number: 100019306. Crown copyright reserved. Unauthorised production infringes copyright.

**LME** LLOYD MORRIS ELECTRICAL LTD  
 100019306  
 Walsby  
 North Yorkshire  
 LL11 2UD  
 TEL: 444 (0)1078 201905  
 E-MAIL: info@lloyd-morris.co.uk

THE DRAWING IS PRIVATE AND CONFIDENTIAL. IT IS ISSUED ON THE ASSURED CONFIDENCE OF THE USER AND IS NOT TO BE COPIED OR COMMUNICATED TO OTHER PARTIES WITHOUT THE PRIOR WRITTEN CONSENT OF LLOYD MORRIS ELECTRICAL LTD

ISSUED BY: CP01  
 CHECKED BY:

USE ONLY: TEMPLATE-001

---

CURRENT ISSUE INFORMATION

ISSUE	DATE	BY	REASON	FOR GUIDANCE ONLY	05/12/19
04				FOR TECHNICAL REVIEW	04

**United Utilities**  
 Water for the North West

---

UI SEWERAGE SECTOR DAC GUIDANCE  
 APPENDIX C ADDENDUM  
 TYPICAL PUMPING STATION CONTROL PANEL CP01  
 DESIGN BUILD INFORMATION SHEET

DATE: N.T.S	SCALE: A3
PROJECT: TBA	ISSUE: PD1

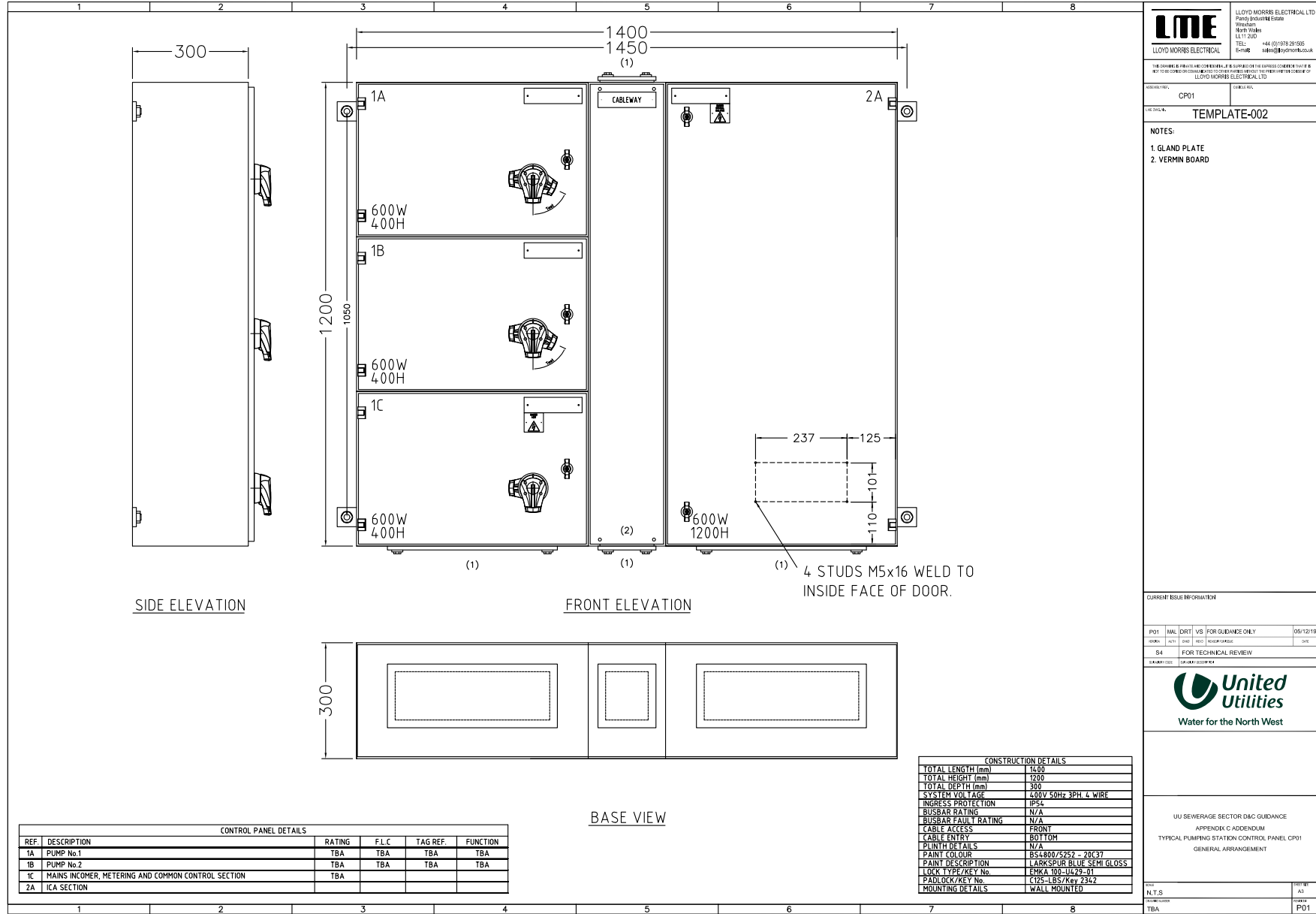

**LME**  
LLOYD MORRIS ELECTRICAL LTD  
LLOYD MORRIS ELECTRICAL

LLOYD MORRIS ELECTRICAL LTD  
2005, DUNDEE ROAD  
WIDEN, NORTH WYKE  
LE11 2UD  
TEL: 444 (0) 1078 201905  
E-MAIL: info@lloyd-morris.co.uk

ISSUE NO. CP01  
CONTRACT NO. TEMPLATE-002

**NOTES:**  
1. GLAND PLATE  
2. VERMIN BOARD

**CURRENT ISSUE INFORMATION**

ISSUE NO.	DATE	BY	FOR GUIDANCE ONLY	DATE
01	05/12/19			
02				
03				
04			FOR TECHNICAL REVIEW	
05				



UI SEWERAGE SECTOR DAC GUIDANCE  
APPENDIX C ADDENDUM  
TYPICAL PUMPING STATION CONTROL PANEL CP01  
GENERAL ARRANGEMENT

DATE	N.T.S	ISSUE NO.	01
PREPARED BY	TBA	CHECKED BY	PO1

© The copyright of this document, which contains information of a proprietary nature, is vested in United Utilities Water PLC. The content of this document may not be used for purposes other than that for which it has been supplied and may not be reproduced, either wholly or in part, in any way whatsoever. It may not be used by, or its contents divulged to any other person whatsoever without the prior written permission of United Utilities Water PLC. Copyright Acknowledgement: Use of Ordnance Survey map data sanctioned by the controller of H.M. Stationery Office. OS Licence Number: 100019026. Crown copyright reserved. Unauthorised production infringes copyright.



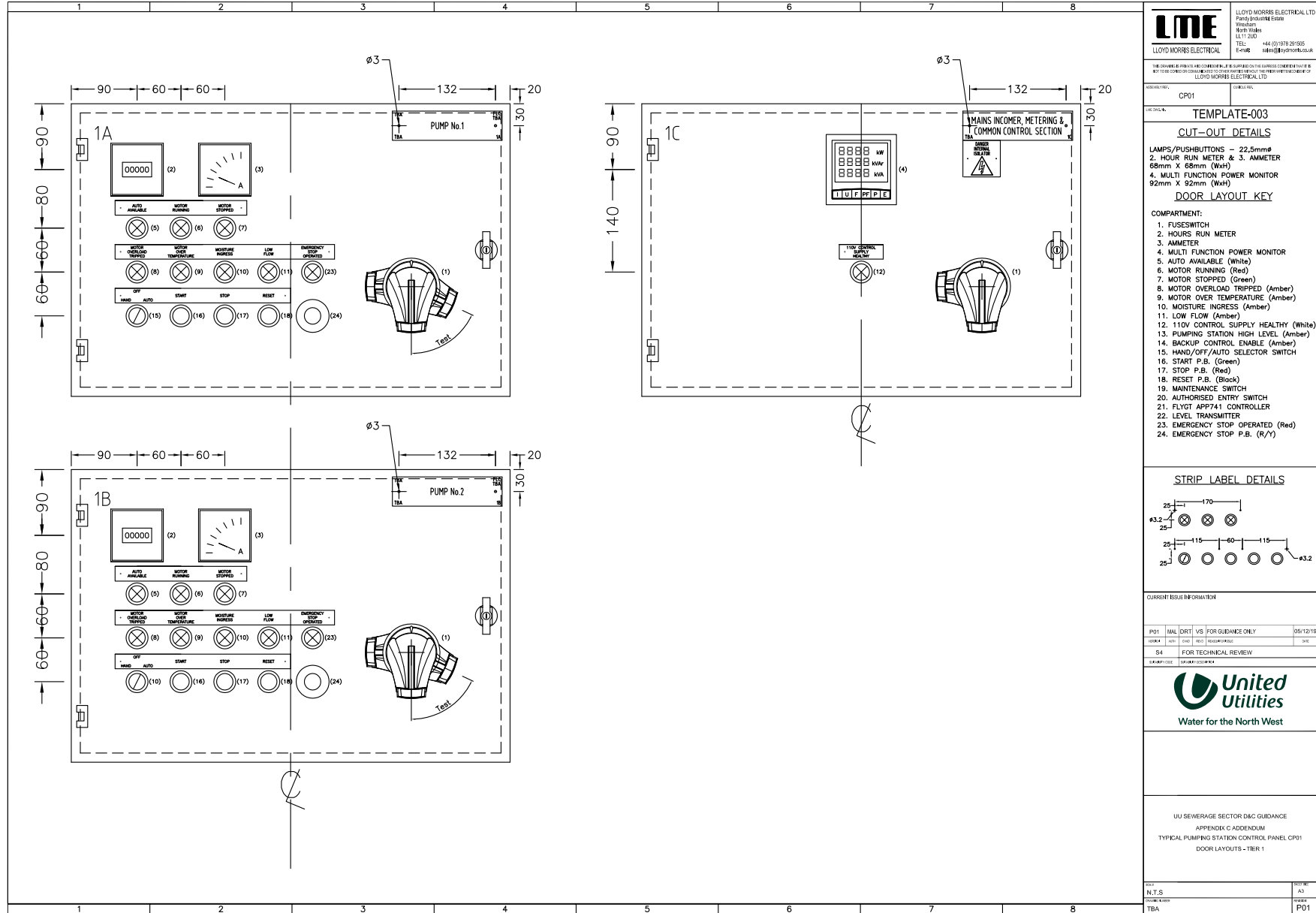

**LME**  
LLOYD MORRIS ELECTRICAL

LLOYD MORRIS ELECTRICAL LTD  
Electric Engineering Services  
Widnes  
North Wales  
LL11 2UD  
TEL: 444 (0)1778 201505  
E-Mail: info@lloyd-morris.co.uk

THE DRAWING IS PROVIDED AS A GUIDE ONLY. IT IS SUPPLIED ON THE UNDERSTANDING THAT IT IS NOT TO BE USED FOR CONSTRUCTION OR TO BE RELIED UPON WITHOUT THE FURNISHING OF A CONTRACT BY LLOYD MORRIS ELECTRICAL LTD.

CP01

TEMPLATE-003

- CUT-OUT DETAILS**
- LAMPS/PUSHBUTTONS - 22.5mm $\phi$
  - HOUR RUN METER & 3. AMMETER 68mm X 68mm (WxH)
  - MULTI FUNCTION POWER MONITOR 92mm X 92mm (WxH)

- DOOR LAYOUT KEY**
- COMPARTMENT:**
- FUSES/WITCH
  - HOURS RUN METER
  - AMMETER
  - MULTI FUNCTION POWER MONITOR
  - AUTO AVAILABLE (White)
  - MOTOR RUNNING (Red)
  - MOTOR STOPPED (Green)
  - MOTOR OVERLOAD TRIPPED (Amber)
  - MOTOR OVER TEMPERATURE (Amber)
  - MOISTURE INGRESS (Amber)
  - LOW FLOW (Amber)
  - 110V CONTROL SUPPLY HEALTHY (White)
  - PUMPING STATION HIGH LEVEL (Amber)
  - BACKUP CONTROL ENABLE (Amber)
  - HAND/OFF/AUTO SELECTOR SWITCH
  - START P.B. (Green)
  - STOP P.B. (Red)
  - RESET P.B. (Black)
  - MAINTENANCE SWITCH
  - AUTHORISED ENTRY SWITCH
  - FLYGT APP741 CONTROLLER
  - LEVEL TRANSMITTER
  - EMERGENCY STOP OPERATED (Red)
  - EMERGENCY STOP P.B. (R/Y)

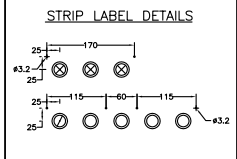

**CURRENT ISSUE INFORMATION**

IP01	MAL	DRY	VS	FOR GUIDANCE ONLY	05/12/19
ISSUE	DATE	ISSUE	ISSUE	ISSUE	DATE
5A	FOR TECHNICAL REVIEW				
5A/01/0001	5A/01/0001				



UI SEWERAGE SECTOR DAC GUIDANCE  
APPENDIX C ADDENDUM  
TYPICAL PUMPING STATION CONTROL PANEL CP01  
DOOR LAYOUTS - TIER 1

DATE	REV	DESCRIPTION
N.T.S	1.0	
PREPARED BY	DATE	ISSUED BY
TBA		PO1

© The copyright of this document, which contains information of a proprietary nature, is vested in United Utilities Water PLC. The content of this document may not be used for purposes other than that for which it has been supplied and may not be reproduced, either wholly or in part, in any way whatsoever. It may not be used by, or its contents divulged to any other person whatsoever without the prior written permission of United Utilities Water PLC. Copyright Acknowledgement: Use of Ordnance Survey map data sanctioned by the controller of H.M. Stationery Office. OS Licence Number: 100019026. Crown copyright reserved. Unauthorised production infringes copyright.

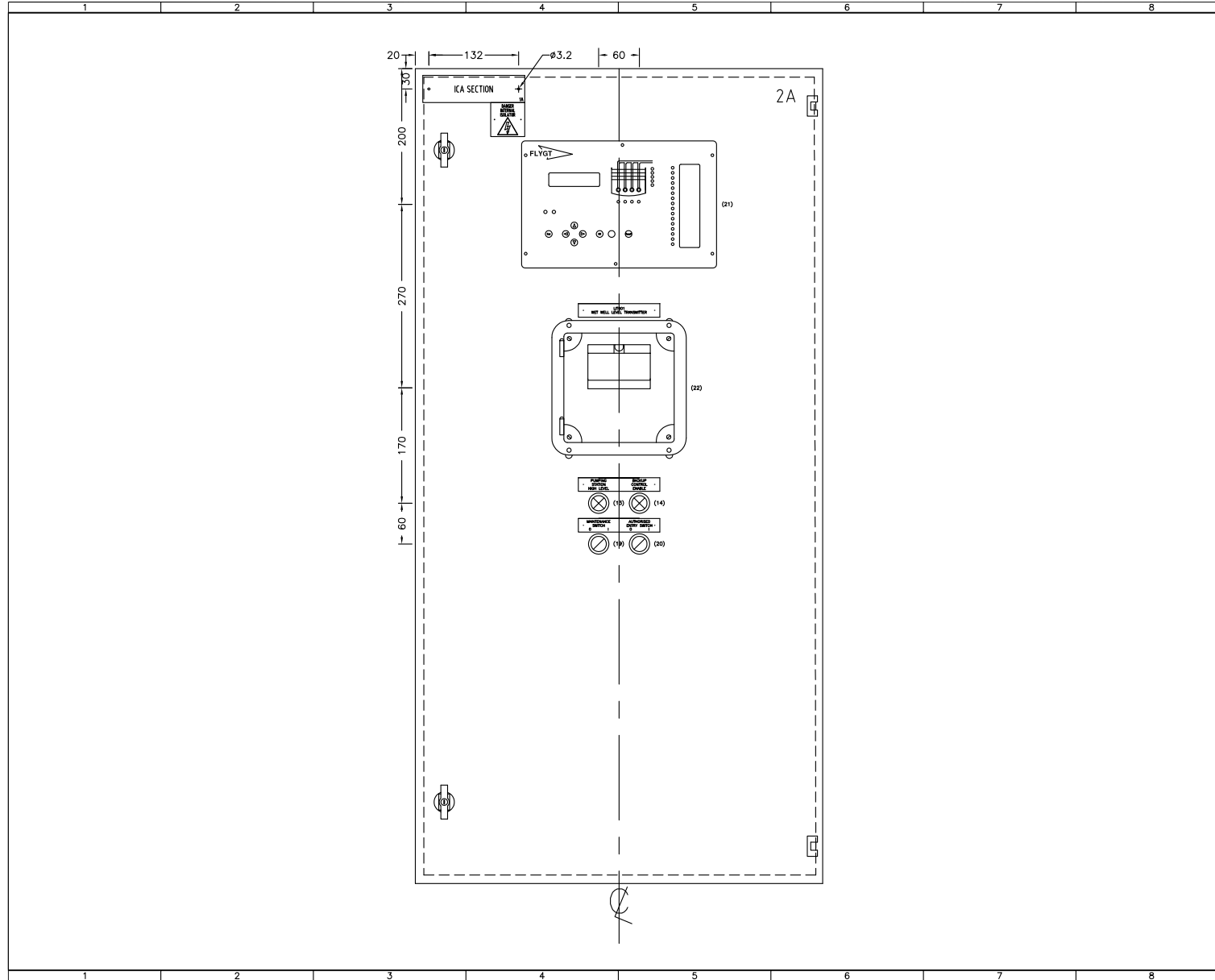

		LLOYD MORRIS ELECTRICAL LTD Factory Business Centre Winton North Wales LL11 2UD TEL: 444 (0)1708 201505 E-MAIL: info@lloyd-morris.co.uk										
THE DRAWING DETAILS ARE CONSIDERED TO BE SUPPLIED ON THE ASSUMED COMPARTMENT FIT AND TO BE CORRECT OR CORRECTED TO FIT THE PARTS WITHOUT THE FURTHER INTERVENTION OF LLOYD MORRIS ELECTRICAL LTD												
DESIGN NO. CP01	CLIENT NO. TEMPLATE-004											
CUT-OUT DETAILS LAMPS/PUSHBUTTONS - 22.5mmφ 21. APP741 FLYGT CONTROLLER 												
22. LEVEL CONTROLLER 												
DOOR LAYOUT KEY COMPARTMENT: 2A SEE DRG 71651-004 FOR DETAILS.												
STRIP LABEL DETAILS 												
CURRENT ISSUE INFORMATION <table border="1"> <tr> <td>ISSUE</td> <td>NO.</td> <td>DATE</td> <td>DESCRIPTION</td> <td>DATE</td> </tr> <tr> <td>01</td> <td>01</td> <td>05/12/19</td> <td>FOR TECHNICAL REVIEW</td> <td></td> </tr> </table>			ISSUE	NO.	DATE	DESCRIPTION	DATE	01	01	05/12/19	FOR TECHNICAL REVIEW	
ISSUE	NO.	DATE	DESCRIPTION	DATE								
01	01	05/12/19	FOR TECHNICAL REVIEW									
<p>Water for the North West</p>												
UU SEWERAGE SECTOR DAC GUIDANCE APPENDIX C ADDENDUM TYPICAL PUMPING STATION CONTROL PANEL CP01 DOOR LAYOUTS - TIER 2												
DATE N.T.S. PROJECT NO. TBA	DRAWN BY P01											

© The copyright of this document, which contains information of a proprietary nature, is vested in United Utilities Water PLC. The content of this document may not be used for purposes other than that for which it has been supplied and may not be reproduced, either wholly or in part, in any way whatsoever. It may not be used by, or its contents divulged to any other person whatsoever without the prior written permission of United Utilities Water PLC. Copyright Acknowledgement: Use of Ordnance Survey map data sanctioned by the controller of H.M. Stationery Office. OS Licence Number: 100019026. Crown copyright reserved. Unauthorised production infringes copyright.

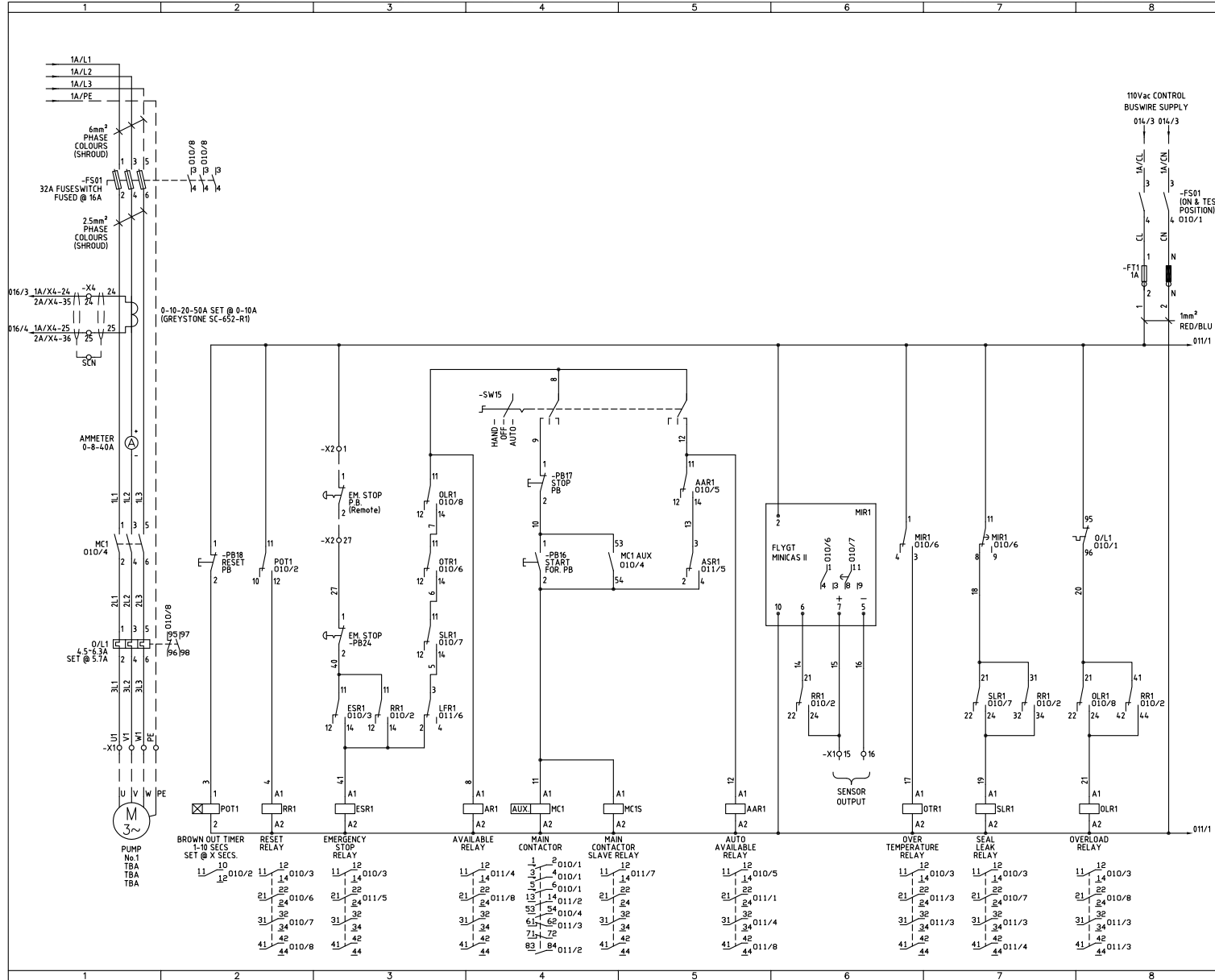

		LLOYD MORRIS ELECTRICAL LTD 25000000000000000000 Winton North Wales LL11 2UD TEL: 01492 201505 E-MAIL: info@lloyd-morris.co.uk	
		APPROVALS: CP01	CHECKED: 1A
LME FILE NO: <b>TEMPLATE-010</b>			
NOTES: 1. DRAWING RATINGS ARE BASED ON A 2.4KV 57A PLC DOL.			
CURRENT ISSUE INFORMATION			
IP01	MAL DRTY	VS FOR GUIDANCE ONLY	05/12/19
54	FOR TECHNICAL REVIEW		DATE
Water for the North West			
UI SEWERAGE SECTOR DAC GUIDANCE APPENDIX C ADDENDUM TYPICAL PUMPING STATION CONTROL PANEL CP01 SCHEMATIC DIAGRAM PUMP No.1			
DATE: N.T.S. PREPARED BY: TBA	CHECKED BY: P01		

© The copyright of this document, which contains information of a proprietary nature, is vested in United Utilities Water PLC. The content of this document may not be used for purposes other than that for which it has been supplied and may not be reproduced, either wholly or in part, in any way whatsoever. It may not be used by, or its contents divulged to any other person whatsoever without the prior written permission of United Utilities Water PLC. Copyright Acknowledgement: Use of Ordnance Survey map data sanctioned by the controller of HM, Stationery Office. OS Licence Number: 100019026. Crown copyright reserved. Unauthorised production infringes copyright.

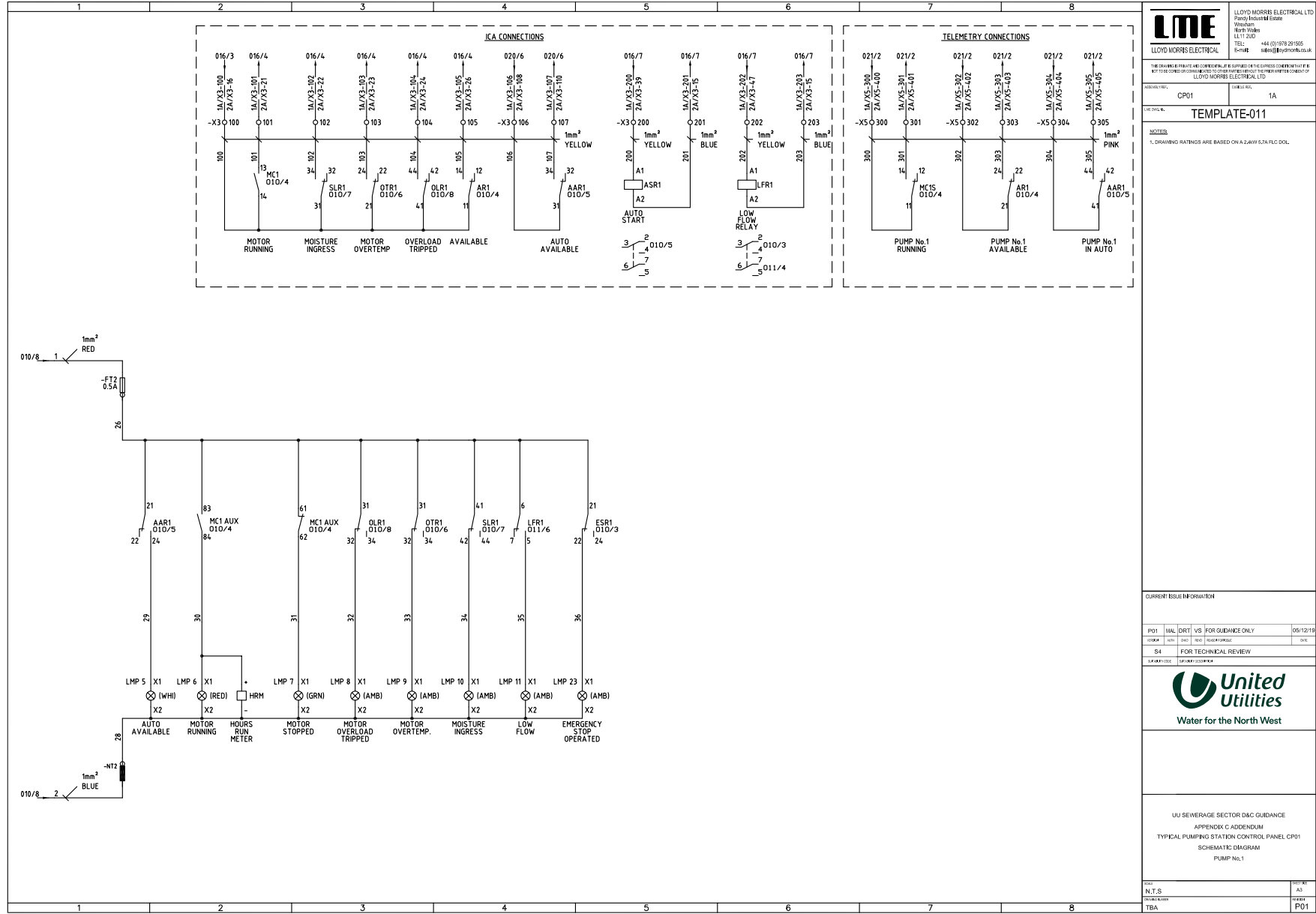

		LLOYD MORRIS ELECTRICAL LTD 2005, Broomfield Road Wetherby, North Yorkshire LS11 2UD TEL: 01937 546464 FAX: 01937 546465 EMAIL: info@lloyd-morris.co.uk	
		CP01	1A
<b>TEMPLATE-011</b>			
NOTES: 1. DRAWING RATINGS ARE BASED ON A 2.4KV 50A PLC DOL.			
CURRENT ISSUE INFORMATION			
IP01	MAL DRY VS	FOR GUIDANCE ONLY	05/12/19
5A	FOR TECHNICAL REVIEW		
 Water for the North West			
UU SEWERAGE SECTOR DAC GUIDANCE APPENDIX C ADDENDUM TYPICAL PUMPING STATION CONTROL PANEL CP01 SCHEMATIC DIAGRAM PUMP No.1			
DATE: N.T.S. PROJECT: TBA	DRAWN BY:	CHECKED BY:	APPROVED BY: P01

© The copyright of this document, which contains information of a proprietary nature, is vested in United Utilities Water PLC. The content of this document may not be used for purposes other than that for which it has been supplied and may not be reproduced, either wholly or in part, in any way whatsoever. It may not be used by, or its contents divulged to any other person whatsoever without the prior written permission of United Utilities Water PLC. Copyright Acknowledgement: Use of Ordnance Survey map data sanctioned by the controller of H.M. Stationery Office. OS Licence Number: 100019026. Crown copyright reserved. Unauthorised production infringes copyright.

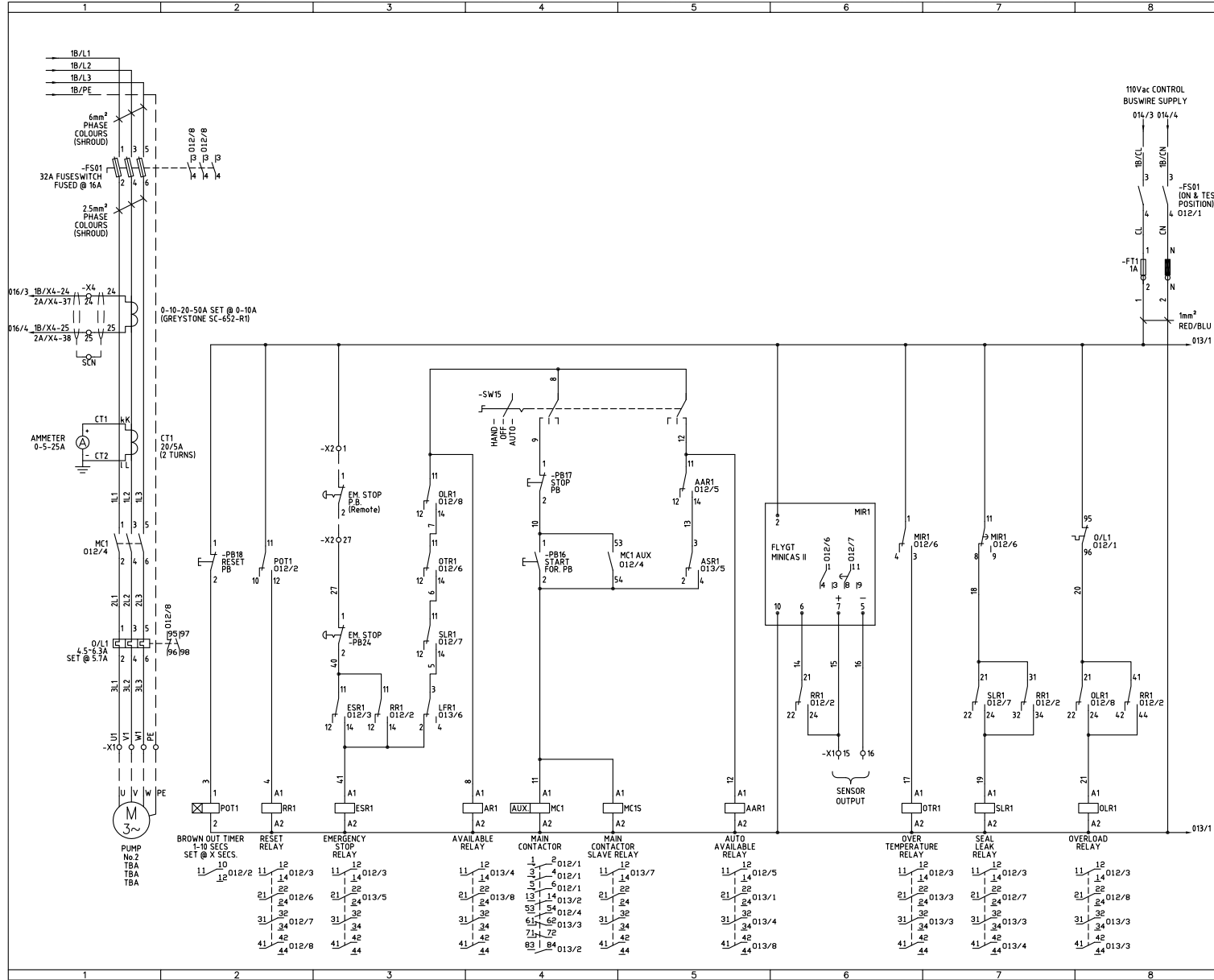

		LLOYD MORRIS ELECTRICAL LTD 2005, Broomfield Road Wotton, North Wales LL11 2UD TEL: 01492 874444 8-14H info@lloyd-morris.co.uk	
		THE DRAWING IS PRIVATE AND CONFIDENTIAL. IT IS SUPPLIED ON THE EXPRESS UNDERSTANDING THAT IT IS NOT TO BE COPIED OR COMMUNICATED TO OTHER PARTIES WITHOUT THE WRITTEN CONSENT OF LLOYD MORRIS ELECTRICAL LTD.	
APPROVALS: CP01	CHECKED BY: 1B	<b>TEMPLATE-012</b>	
NOTES: 1. DRAWING RATINGS ARE BASED ON A 2.4KV 67A PLC DOL.			
CURRENT ISSUE INFORMATION			
IP01	MAL DRT	VS FOR GUIDANCE ONLY	05/12/19
54	FOR TECHNICAL REVIEW		04/
 Water for the North West			
UI SEWERAGE SECTOR DAC GUIDANCE APPENDIX C ADDENDUM TYPICAL PUMPING STATION CONTROL PANEL CP01 SCHEMATIC DIAGRAM PUMP No 2			
DATE: N.T.S. PREPARED BY: TBA	DRAWN BY: P01		

© The copyright of this document, which contains information of a proprietary nature, is vested in United Utilities Water PLC. The content of this document may not be used for purposes other than that for which it has been supplied and may not be reproduced, either wholly or in part, in any way whatsoever. It may not be used by, or its contents divulged to any other person whatsoever without the prior written permission of United Utilities Water PLC. Copyright Acknowledgement: Use of Ordnance Survey map data sanctioned by the controller of HM, Stationery Office. OS Licence Number: 100019026. Crown copyright reserved. Unauthorised production infringes copyright.

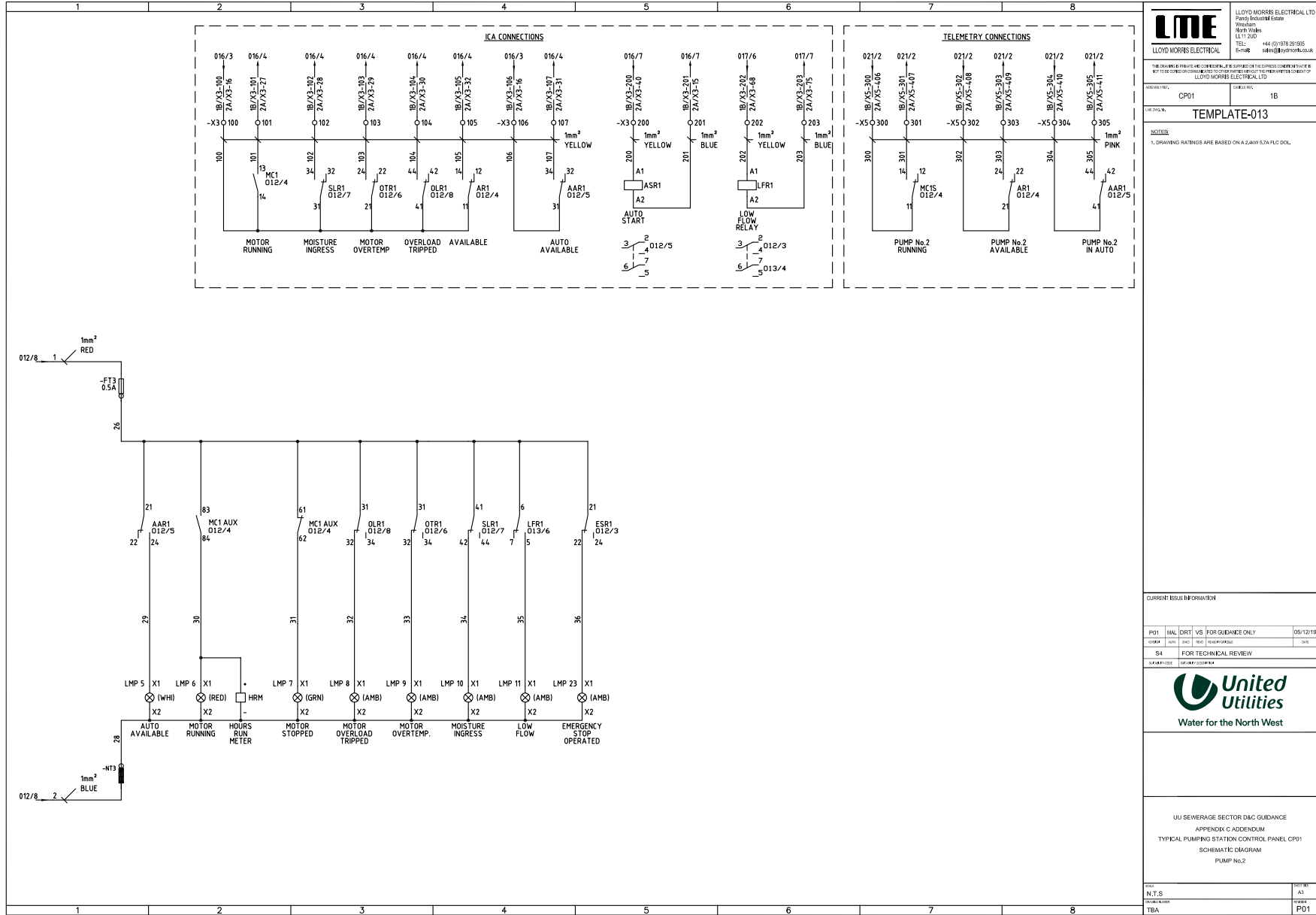

© The copyright of this document, which contains information of a proprietary nature, is vested in United Utilities Water PLC. The content of this document may not be used for purposes other than that for which it has been supplied and may not be reproduced, either wholly or in part, in any way whatsoever. It may not be used by, or its contents divulged to any other person whatsoever without the prior written permission of United Utilities Water PLC. Copyright Acknowledgement: Use of Ordnance Survey map data sanctioned by the controller of H.M. Stationery Office. OS Licence Number: 100019026. Crown copyright reserved. Unauthorised production infringes copyright.

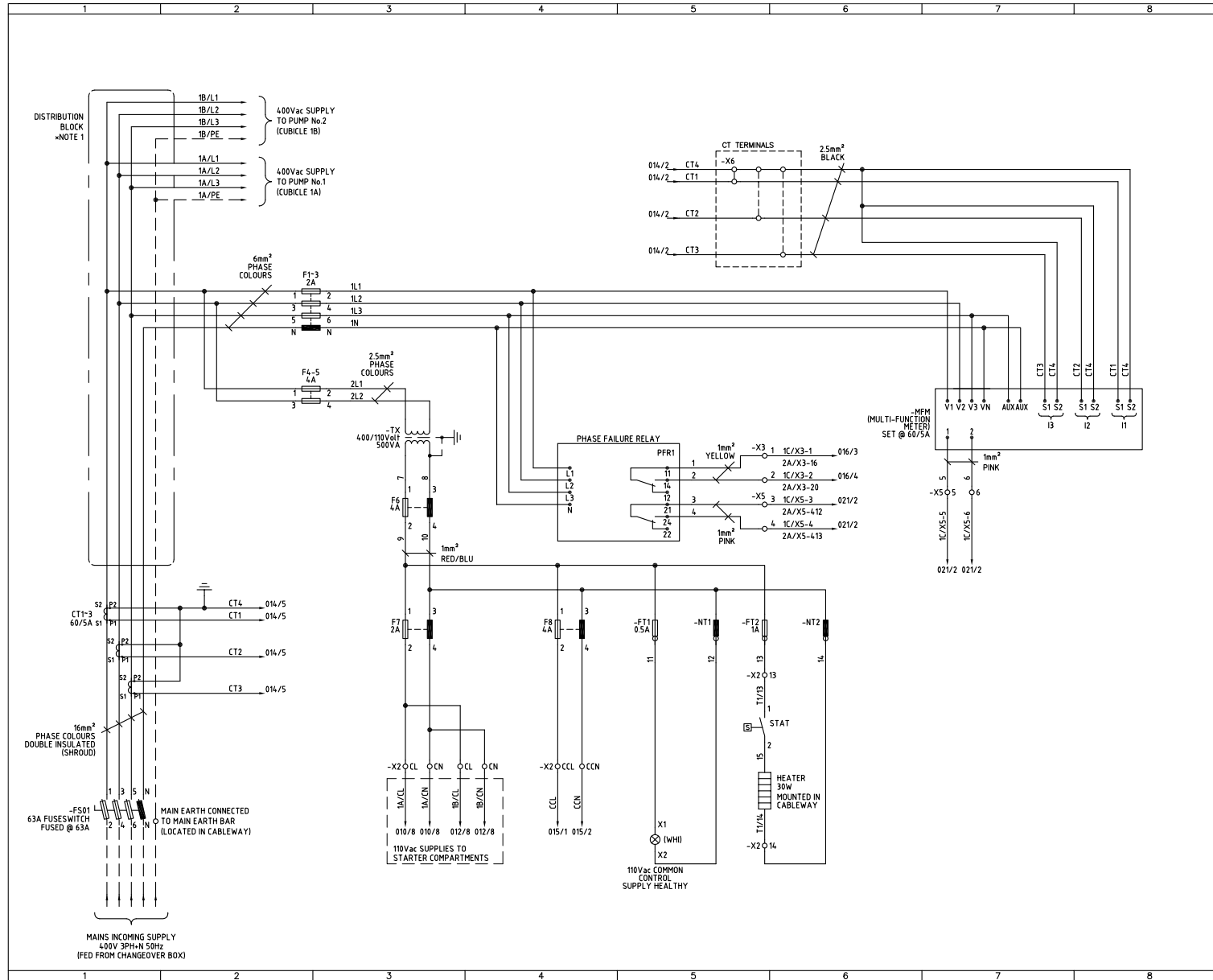

© The copyright of this document, which contains information of a proprietary nature, is vested in United Utilities Water PLC. The content of this document may not be used for purposes other than that for which it has been supplied and may not be reproduced, either wholly or in part, in any way whatsoever. It may not be used by, or its contents divulged to any other person whatsoever without the prior written permission of United Utilities Water PLC. Copyright Acknowledgement: Use of Ordnance Survey map data sanctioned by the controller of HM, Stationery Office. OS Licence Number: 100019026. Crown copyright reserved. Unauthorised production infringes copyright.

<b>LME</b> LLOYD MORRIS ELECTRICAL		LLOYD MORRIS ELECTRICAL LTD 25005 BIRCHWOOD ROAD WIRRAL MERSEY SIDES LL11 2UD TEL: 0151 478 21505 E-MAIL: info@lloyd-morris.co.uk
THE DRAWING IS PRIVATE AND CONFIDENTIAL. IT IS SUPPLIED ON THE EXPRESS UNDERSTANDING THAT IT IS NOT TO BE COPIED OR COMMUNICATED TO OTHER PARTIES WITHOUT THE WRITTEN CONSENT OF LLOYD MORRIS ELECTRICAL LTD.		
DESIGNATED:	CP01	CONTRACT NO.: 1C
USE ONLY:	<b>TEMPLATE-014</b>	
NOTES: 1. DRAWING RATINGS ARE BASED ON A 60A FUSESWATCH.		
CURRENT ISSUE INFORMATION		
ISSUE NO:	ISSUE DATE:	ISSUE DESCRIPTION:
IP01	MAL DRTY VS	FOR GUIDANCE ONLY 05/12/19
SA	FOR TECHNICAL REVIEW	
 Water for the North West		
UU SEWERAGE SECTOR DAC GUIDANCE APPENDIX C ADDENDUM TYPICAL PUMPING STATION CONTROL PANEL CP01 SCHEMATIC DIAGRAM MAINS INCOMER		
DATE:	BY:	CHKD:
N.T.S	REVISION:	REV:
TBA		PO1



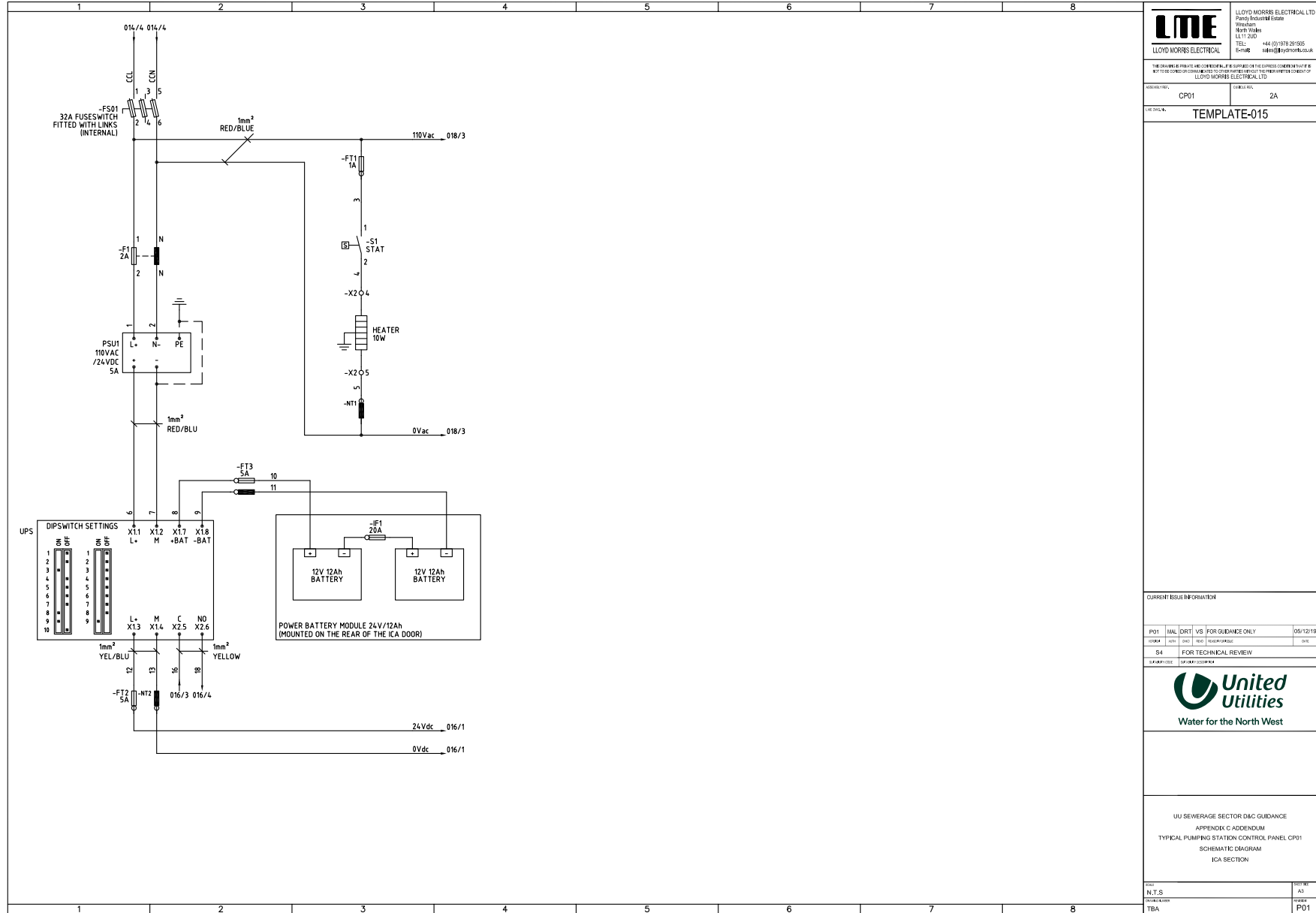

	LLOYD MORRIS ELECTRICAL LTD Energy Efficiency Centre Whitehall North Wales LL11 2UD TEL: 444 (0)1778 201505 E-MAIL: info@lloyd-morris.co.uk
	THE DRAWING IS PRIVATE AND CONFIDENTIAL. IT IS SUPPLIED ON THE EXPRESS UNDERSTANDING THAT IT IS NOT TO BE COPIED OR COMMUNICATED TO OTHER PARTIES WITHOUT THE WRITTEN CONSENT OF LLOYD MORRIS ELECTRICAL LTD

APPROVALS: CP01	CHECKED BY: 2A
LME DRAWING NO: <b>TEMPLATE-015</b>	

CURRENT ISSUE INFORMATION			
ISSUE NO:	ISSUE DATE:	ISSUE DESCRIPTION:	DATE:
01	05/12/19	FOR TECHNICAL REVIEW	
DRAWING CODE: 015/001/00000000			

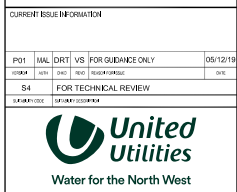

UU SEWERAGE SECTOR DAC GUIDANCE APPENDIX C ADDENDUM TYPICAL PUMPING STATION CONTROL PANEL CP01 SCHEMATIC DIAGRAM ICA SECTION	
DATE: N.T.S. PROJECT NO: TBA	DRAWN BY: A.J. CHECKED BY: P01

© The copyright of this document, which contains information of a proprietary nature, is vested in United Utilities Water PLC. The content of this document may not be used for purposes other than that for which it has been supplied and may not be reproduced, either wholly or in part, in any way whatsoever. It may not be used by, or its contents divulged to any other person whatsoever without the prior written permission of United Utilities Water PLC. Copyright Acknowledgement: Use of Ordnance Survey map data sanctioned by the controller of H.M. Stationery Office. OS Licence Number: 100019326. Crown copyright reserved. Unauthorised production infringes copyright.

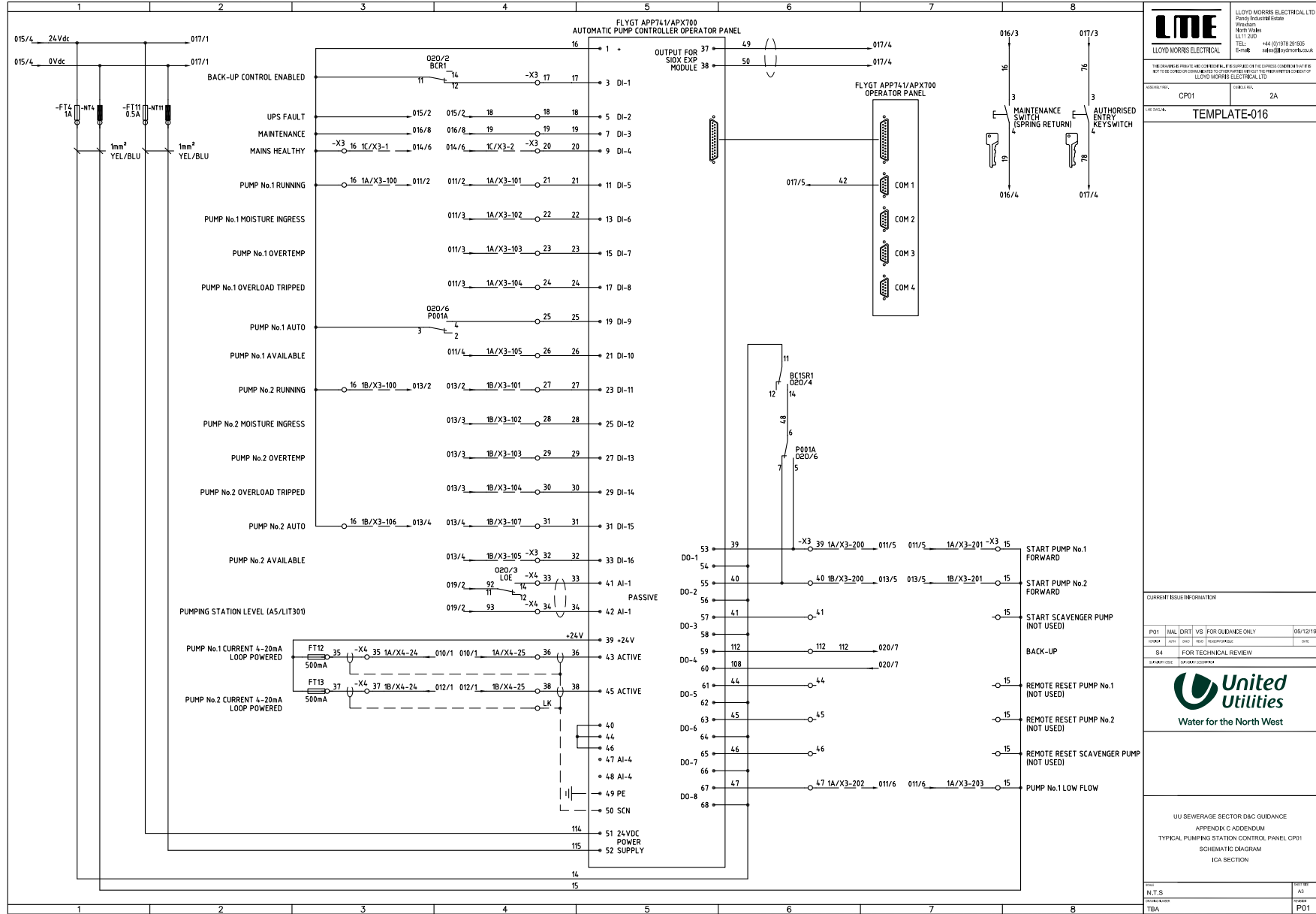

		LLOYD MORRIS ELECTRICAL LTD 20050100000000000000 Winton North Yorkshire LL11 2UD TEL: 01430 821505 FAX: 01430 821506 EMAIL: lme@lloyd-morris.co.uk	
		THE DRAWING IS PRIVATE AND CONFIDENTIAL. IT IS ISSUED ON THE EXPRESS UNDERSTANDING THAT IT IS NOT TO BE COPIED OR COMMUNICATED TO OTHER PARTIES WITHOUT THE WRITTEN PERMISSION OF LLOYD MORRIS ELECTRICAL LTD.	CP01
TEMPLATE-016			
CURRENT ISSUE INFORMATION			
IP01	MAL	DRT	VS FOR GUIDANCE ONLY 05/12/19
5A	FOR TECHNICAL REVIEW	DATE	DATE
 Water for the North West			
UU SEWERAGE SECTOR DAC GUIDANCE APPENDIX C ADDENDUM TYPICAL PUMPING STATION CONTROL PANEL CP01 SCHEMATIC DIAGRAM IGA SECTION			
DATE N.T.S. PROJECT NO. TBA	DRAWN BY P01	CHECKED BY P01	DATE P01

© The copyright of this document, which contains information of a proprietary nature, is vested in United Utilities Water PLC. The content of this document may not be used for purposes other than that for which it has been supplied and may not be reproduced, either wholly or in part, in any way whatsoever. It may not be used by, or its contents divulged to any other person whatsoever without the prior written permission of United Utilities Water PLC. Copyright Acknowledgement: Use of Ordnance Survey map data sanctioned by the controller of H.M. Stationery Office. OS Licence Number: 100019026. Crown copyright reserved. Unauthorised production infringes copyright.

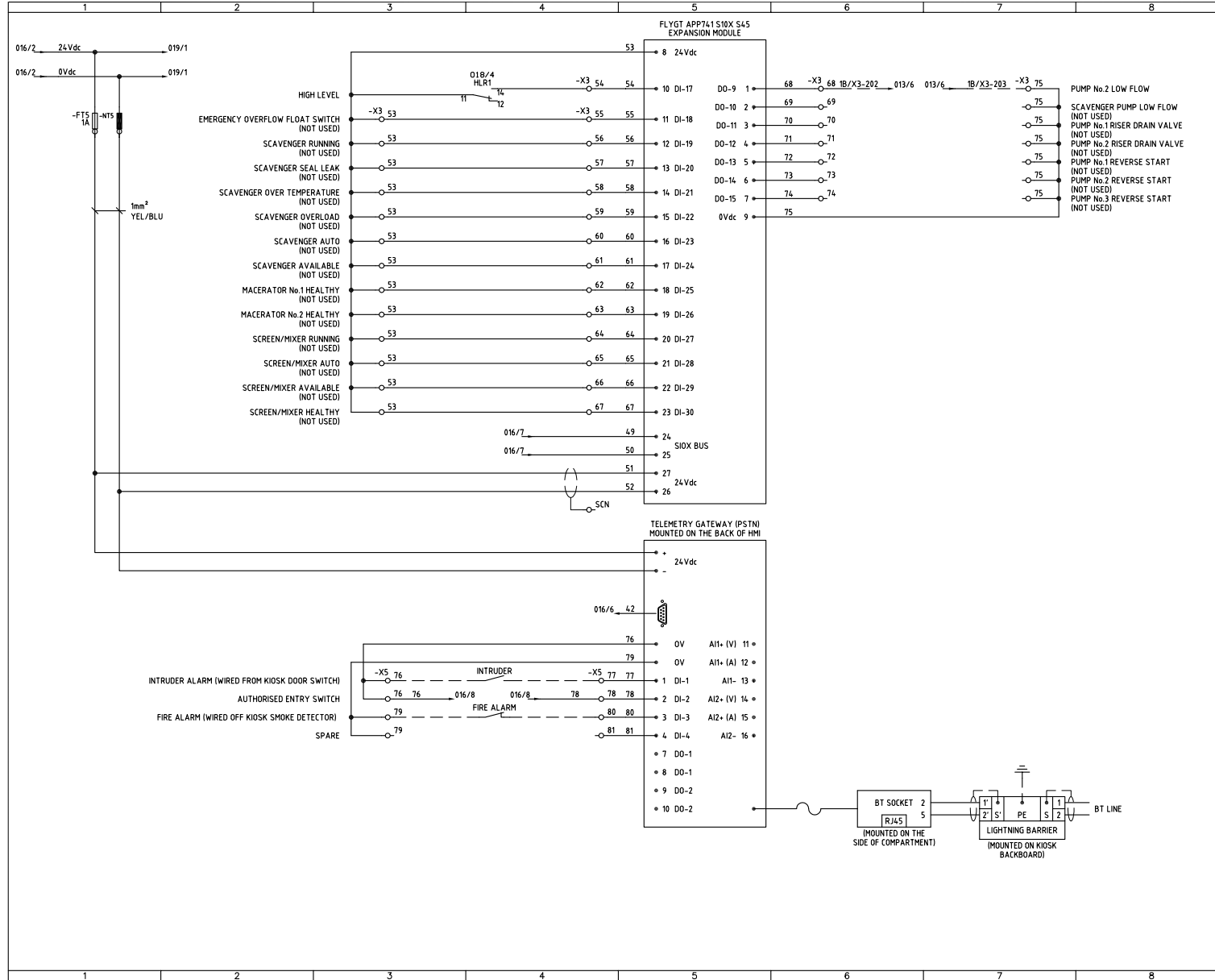

<b>LME</b>		LLOYD MORRIS ELECTRICAL LTD Specialist in Water Treatment LL11 2UD TELE: 01493 821505 E-MAIL: info@lloyd-morris.co.uk	
THE DRAWING IS PRIVATE AND CONFIDENTIAL. IT IS SUPPLIED ON THE EXPRESS UNDERSTANDING THAT IT IS NOT TO BE COPIED OR COMMUNICATED TO OTHER PARTIES WITHOUT THE WRITTEN CONSENT OF LLOYD MORRIS ELECTRICAL LTD.			
DESIGNATED:	CP01	CONTRACT NO.:	2A
USE ONLY:	<b>TEMPLATE-017</b>		
CURRENT ISSUE INFORMATION			
ISSUE NO.	ISSUE DATE	ISSUE DESCRIPTION	DATE
01	05/12/19	FOR TECHNICAL REVIEW	05/12/19
 Water for the North West			
UU SEWERAGE SECTOR DAC GUIDANCE APPENDIX C ADDENDUM TYPICAL PUMPING STATION CONTROL PANEL CP01 SCHEMATIC DIAGRAM ICA SECTION			
DATE:	N.T.S	SCALE:	1:1
PROJECT NO.:	TBA	REVISION:	P01

© The copyright of this document, which contains information of a proprietary nature, is vested in United Utilities Water PLC. The content of this document may not be used for purposes other than that for which it has been supplied and may not be reproduced, either wholly or in part, in any way whatsoever. It may not be used by, or its contents divulged to any other person whatsoever without the prior written permission of United Utilities Water PLC. Copyright Acknowledgement: Use of Ordnance Survey map data sanctioned by the controller of H.M. Stationery Office. OS Licence Number: 100019026. Crown copyright reserved. Unauthorised production infringes copyright.

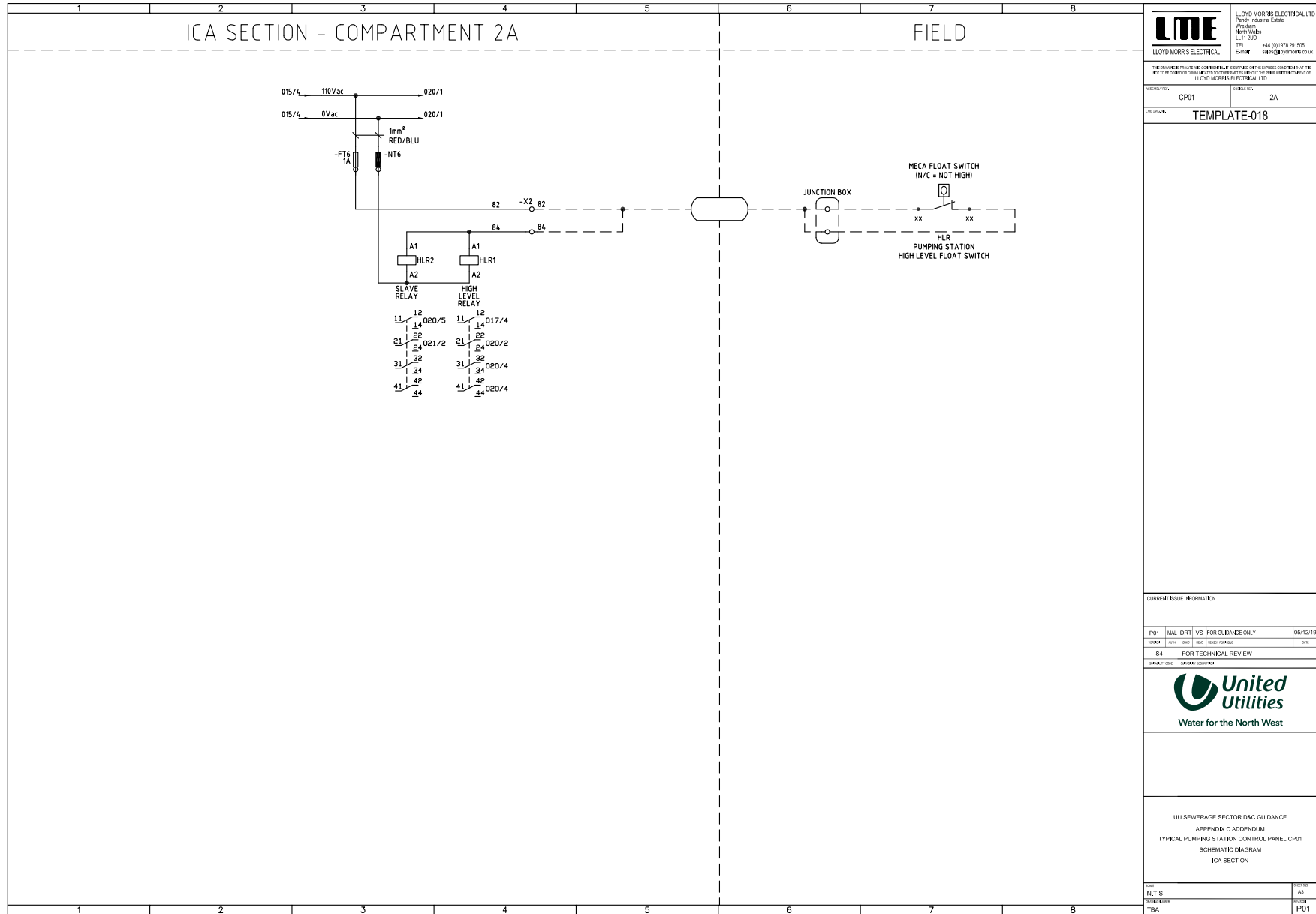

<b>LME</b> LLOYD MORRIS ELECTRICAL		LLOYD MORRIS ELECTRICAL LTD PO BOX 10000 Widnes Merseyside LL11 2UD TEL: 444 (0) 1778 201505 E-MAIL: info@lloyd-morris.co.uk	
THE DRAWING IS PRIVATE AND CONFIDENTIAL. IT IS SUPPLIED ON THE EXPRESS UNDERSTANDING THAT IT IS NOT TO BE COPIED OR COMMUNICATED TO OTHER PARTIES WITHOUT THE WRITTEN CONSENT OF LLOYD MORRIS ELECTRICAL LTD			
ISSUE NO.	CP01	COMP NO.	2A
TEMPLATE-018			
CURRENT ISSUE INFORMATION			
ISSUE NO.	ISSUE DATE	ISSUE BY	ISSUE FOR
01	05/12/19	VS	FOR GUIDANCE ONLY
02		SA	FOR TECHNICAL REVIEW
 Water for the North West			
UU SEWERAGE SECTOR DAC GUIDANCE APPENDIX C ADDENDUM TYPICAL PUMPING STATION CONTROL PANEL CP01 SCHEMATIC DIAGRAM ICA SECTION			
DATE	N.T.S	SCALE	AS SHOWN
REVISION	TBA	REVISION	P01

© The copyright of this document, which contains information of a proprietary nature, is vested in United Utilities Water PLC. The content of this document may not be used for purposes other than that for which it has been supplied and may not be reproduced, either wholly or in part, in any way whatsoever. It may not be used by, or its contents divulged to any other person whatsoever without the prior written permission of United Utilities Water PLC. Copyright Acknowledgement: Use of Ordnance Survey map data sanctioned by the controller of H.M. Stationery Office. OS Licence Number: 100019326. Crown copyright reserved. Unauthorised production infringes copyright.

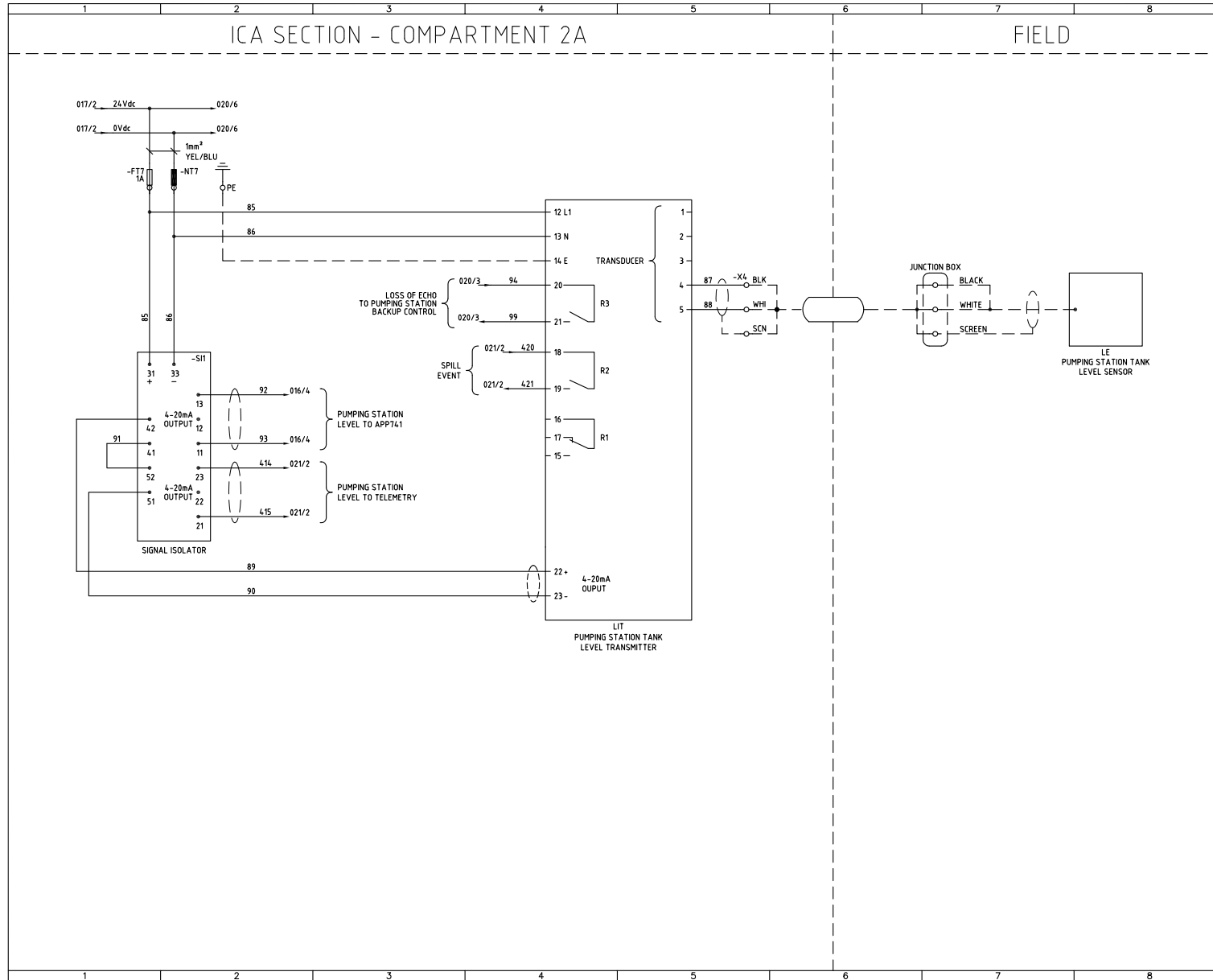

<b>LME</b> LLOYD MORRIS ELECTRICAL LTD		LLOYD MORRIS ELECTRICAL LTD 2005, TROSCHEE ROAD WIDEN, NORTH WYKE LE11 2UD TEL: 444 (0)1509 201505 E-MAIL: info@lloyd-morris.co.uk	
THE DRAWING IS PRIVATE AND CONFIDENTIAL. IT IS SUPPLIED ON THE EXPRESS UNDERSTANDING THAT IT IS NOT TO BE COPIED OR COMMUNICATED TO OTHER PARTIES WITHOUT THE PRIOR WRITTEN CONSENT OF LLOYD MORRIS ELECTRICAL LTD.			
ISSUE NO.	CP01	COMP. NO.	2A
LME FILE NO. <b>TEMPLATE-019</b>			
CURRENT ISSUE INFORMATION			
ISSUE NO.	ISSUE DATE	ISSUE DESCRIPTION	DATE
01	05/12/19	FOR GUIDANCE ONLY	
02		FOR TECHNICAL REVIEW	
 <b>United Utilities</b> Water for the North West			
UU SEWERAGE SECTOR DAC GUIDANCE APPENDIX C ADDENDUM TYPICAL PUMPING STATION CONTROL PANEL CP01 SCHEMATIC DIAGRAM ICA SECTION			
DATE	N.T.S.	ISSUE NO.	01
REVISION	TBA	ISSUE NO.	P01

© The copyright of this document, which contains information of a proprietary nature, is vested in United Utilities Water PLC. The content of this document may not be used for purposes other than that for which it has been supplied and may not be reproduced, either wholly or in part, in any way whatsoever. It may not be used by, or its contents divulged to any other person whatsoever without the prior written permission of United Utilities Water PLC. Copyright Acknowledgement: Use of Ordnance Survey map data sanctioned by the controller of H.M. Stationery Office. OS Licence Number: 100019326. Crown copyright reserved. Unauthorised production infringes copyright.

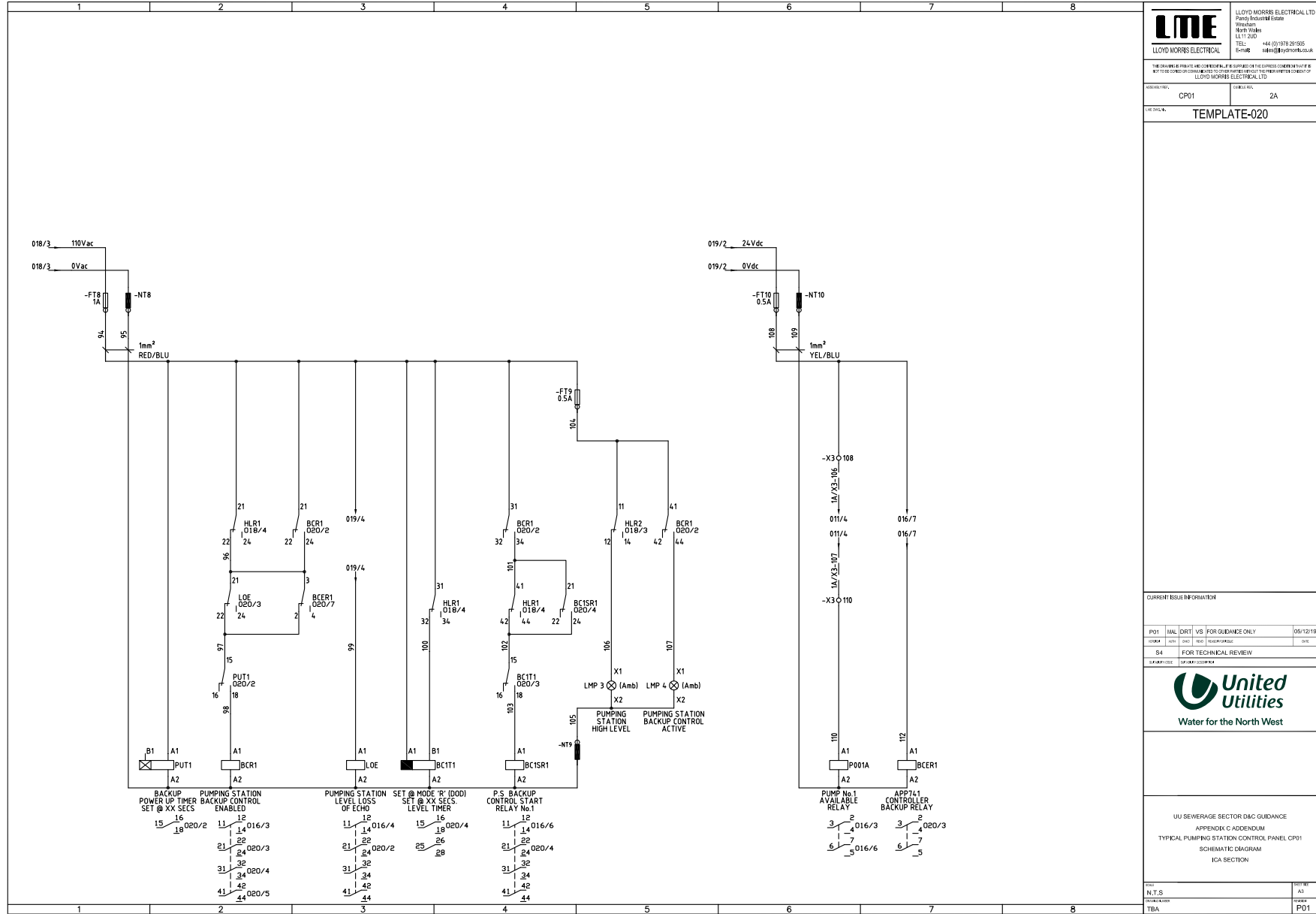

© The copyright of this document, which contains information of a proprietary nature, is vested in United Utilities Water PLC. The content of this document may not be used for purposes other than that for which it has been supplied and may not be reproduced, either wholly or in part, in any way whatsoever. It may not be used by, or its contents divulged to any other person whatsoever without the prior written permission of United Utilities Water PLC. Copyright Acknowledgement: Use of Ordnance Survey map data sanctioned by the controller of HM, Stationery Office. OS Licence Number: 100019026. Crown copyright reserved. Unauthorised production infringes copyright.

		LLOYD MORRIS ELECTRICAL LTD 2005, Broomfield Road Wotton, North Wales LL11 2UD TEL: 01492 884444 EMAIL: info@lloyd-morris.co.uk
THE DRAWING IS PRIVATE AND CONFIDENTIAL. IT IS SUPPLIED ON THE EXPRESS UNDERSTANDING THAT IT IS NOT TO BE COPIED OR COMMUNICATED TO OTHER PARTIES WITHOUT THE PRIOR WRITTEN CONSENT OF LLOYD MORRIS ELECTRICAL LTD.		
APPROVALS: CP01	CHECKED BY: 2A	
LME DRAWING <b>TEMPLATE-020</b>		
CURRENT ISSUE INFORMATION		
IP01	MAL DRY VS	FOR GUIDANCE ONLY 05/12/19
04	FOR TECHNICAL REVIEW	DATE
<p>Water for the North West</p>		
UU SEWERAGE SECTOR DAC GUIDANCE APPENDIX C ADDENDUM TYPICAL PUMPING STATION CONTROL PANEL CP01 SCHEMATIC DIAGRAM ICA SECTION		
DATE N.T.S. PROJECT NO. TBA	DRAWN BY P01	CHECKED BY P01

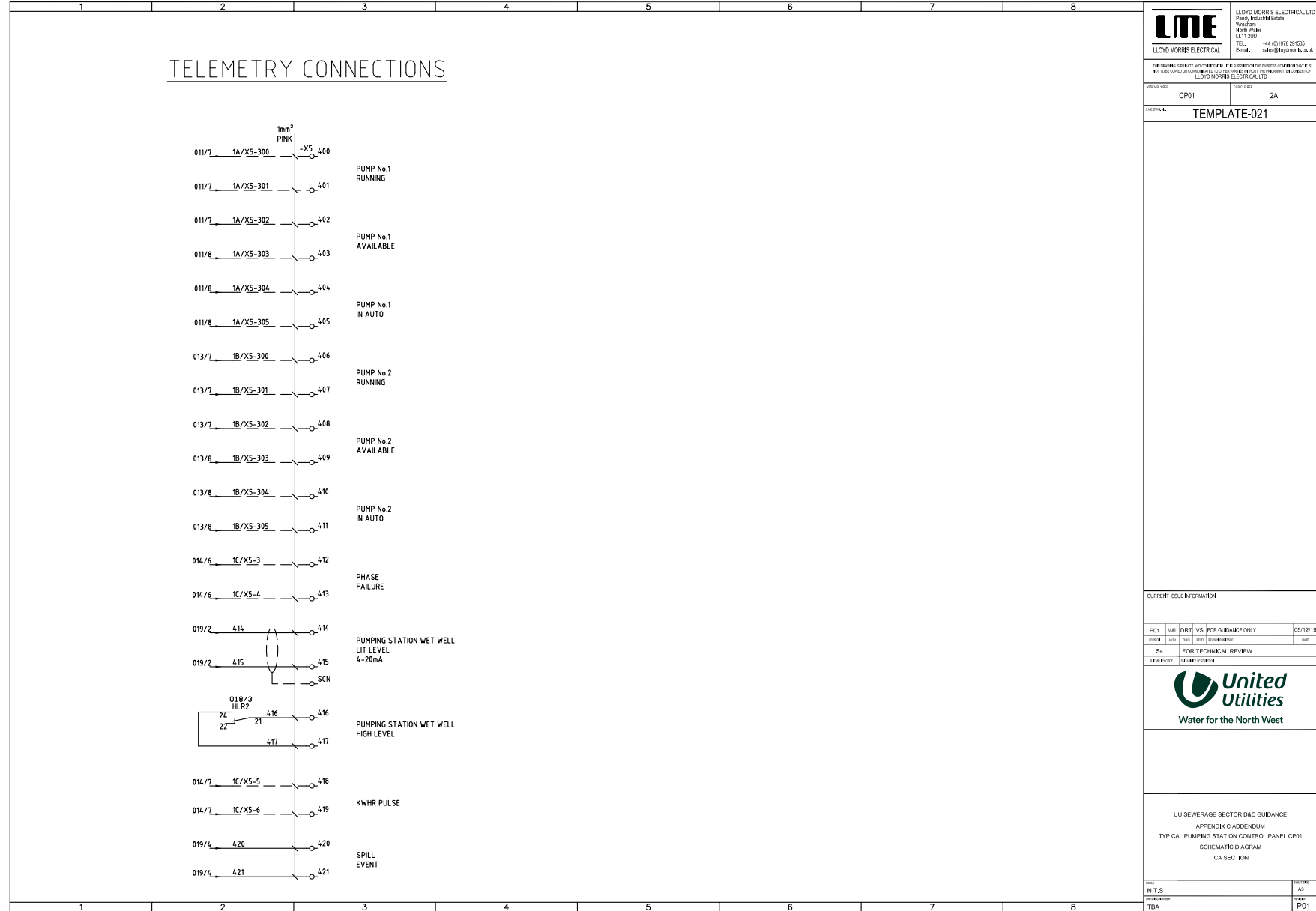

<b>LME</b> LLOYD MORRIS ELECTRICAL	LLOYD MORRIS ELECTRICAL LTD 2005, BUCKINGHAM HOUSE WILKINSON MERTON VALLEY LL11 2UD TEL: 444 (0) 1078 201505 E: lme@lme.co.uk
---------------------------------------	---

THIS DRAWING IS PRIVATE AND CONFIDENTIAL. IT IS SUPPLIED ON THE EXPRESS UNDERSTANDING THAT IT IS NOT TO BE COPIED OR COMMUNICATED TO OTHER PARTIES WITHOUT THE PRIOR WRITTEN CONSENT OF LLOYD MORRIS ELECTRICAL LTD.

ISSUE NO.	CP01	CONTRACT NO.	2A
-----------	------	--------------	----

TEMPLATE-021

CURRENT ISSUE INFORMATION				
ISSUE NO.	ISSUE DATE	ISSUE BY	ISSUE FOR	ISSUE DATE
01	05/12/19	...	FOR GUIDANCE ONLY	05/12/19
02	...	...	FOR TECHNICAL REVIEW	...



UU SEWERAGE SECTOR DAC GUIDANCE  
APPENDIX C ADDENDUM  
TYPICAL PUMPING STATION CONTROL PANEL CP01  
SCHEMATIC DIAGRAM  
ICA SECTION

DATE	N.T.S.	ISSUE NO.	CP01
PROJECT NO.	TBA	ISSUE DATE	...

© The copyright of this document, which contains information of a proprietary nature, is vested in United Utilities Water PLC. The content of this document may not be used for purposes other than that for which it has been supplied and may not be reproduced, either wholly or in part, in any way whatsoever. It may not be used by, or its contents divulged to any other person whatsoever without the prior written permission of United Utilities Water PLC. Copyright Acknowledgement: Use of Ordnance Survey map data sanctioned by the controller of H.M. Stationery Office. OS Licence Number: 100019326. Crown copyright reserved. Unauthorised production infringes copyright.



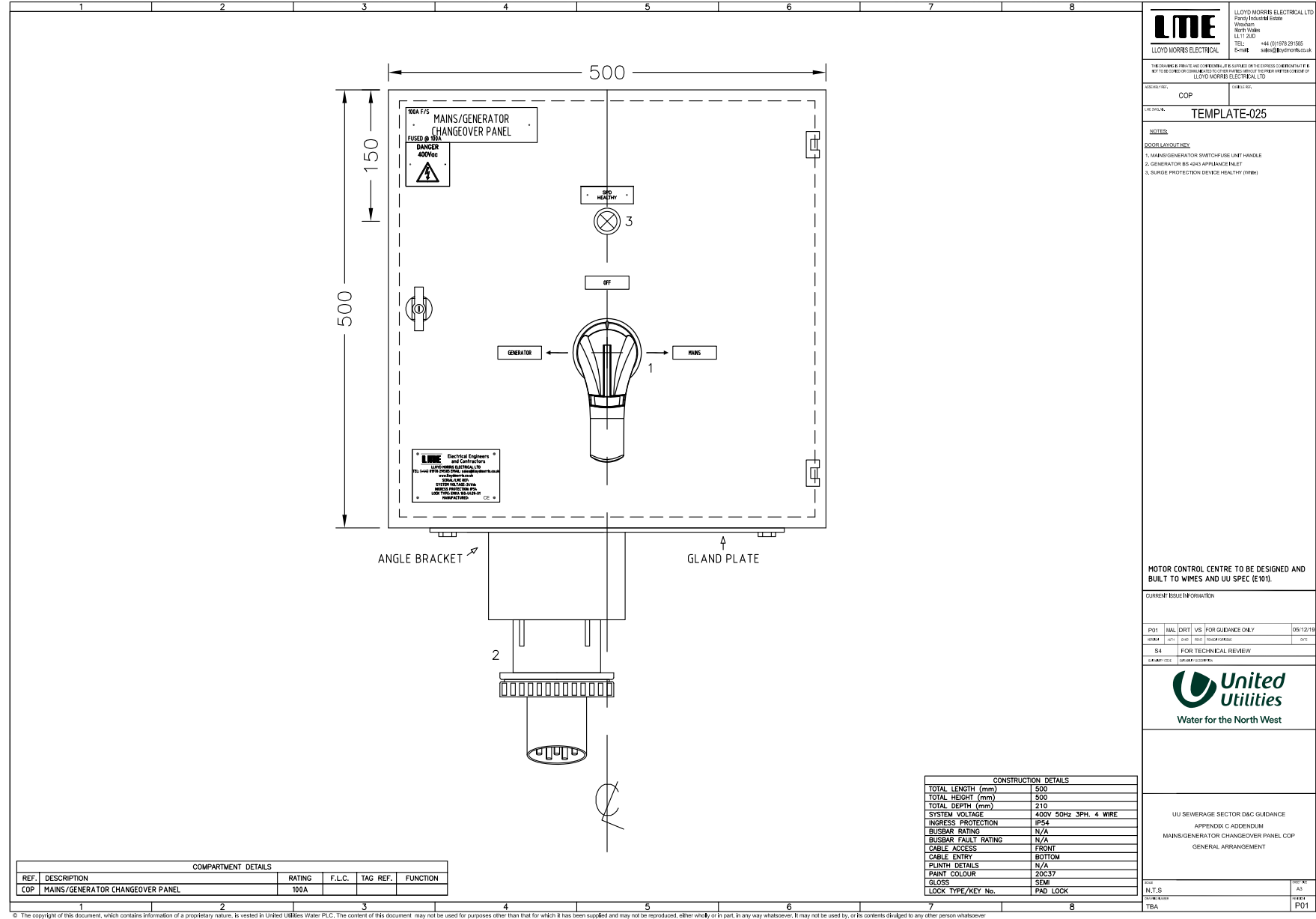

**LME**  
LLOYD MORRIS ELECTRICAL LTD  
2005, TROSCHEE ROAD  
WIDEN, NORTH WILTSHIRE  
WILTSHIRE, WILTSHIRE  
LL11 2UD  
TEL: 01453 624444  
E-MAIL: info@lloyd-morris.co.uk

THE DRAWING IS PRIVATE AND CONFIDENTIAL. IT IS SUPPLIED ON THE EXPRESS UNDERSTANDING THAT IT IS NOT TO BE COPIED OR COMMUNICATED TO OTHER PARTIES WITHOUT THE WRITTEN PERMISSION OF LLOYD MORRIS ELECTRICAL LTD.

DESIGNATED: COP  
DRAWING NO: TEMPLATE-025

**NOTES:**  
DOOR LAYOUT KEY:  
1. MAINS GENERATOR SWITCH/FUSE UNIT HANDLE  
2. GENERATOR BUS BARS APPROXIMATE INLET  
3. SURGE PROTECTION DEVICE HEALTHY (VPH)

MOTOR CONTROL CENTRE TO BE DESIGNED AND BUILT TO WIMES AND UU SPEC (E101).

CURRENT ISSUE INFORMATION				
ISSUE NO.	DATE	ISSUE TYPE	FOR GUIDANCE ONLY	DATE
01	05/12/19	FOR TECHNICAL REVIEW		



UU SEWERAGE SECTOR DAC GUIDANCE  
APPENDIX C ADDENDUM  
MAINS/GENERATOR CHANGEOVER PANEL COP  
GENERAL ARRANGEMENT

REV	DESCRIPTION	DATE
01	N.T.S	05/12/19
02	FOR T&E	
03	T&E	

© The copyright of this document, which contains information of a proprietary nature, is vested in United Utilities Water PLC. The content of this document may not be used for purposes other than that for which it has been supplied and may not be reproduced, either wholly or in part, in any way whatsoever. It may not be used by, or its contents divulged to any other person whatsoever without the prior written permission of United Utilities Water PLC. Copyright Acknowledgement: Use of Ordnance Survey map data sanctioned by the controller of H.M. Stationery Office. OS Licence Number: 100019026. Crown copyright reserved. Unauthorised production infringes copyright.

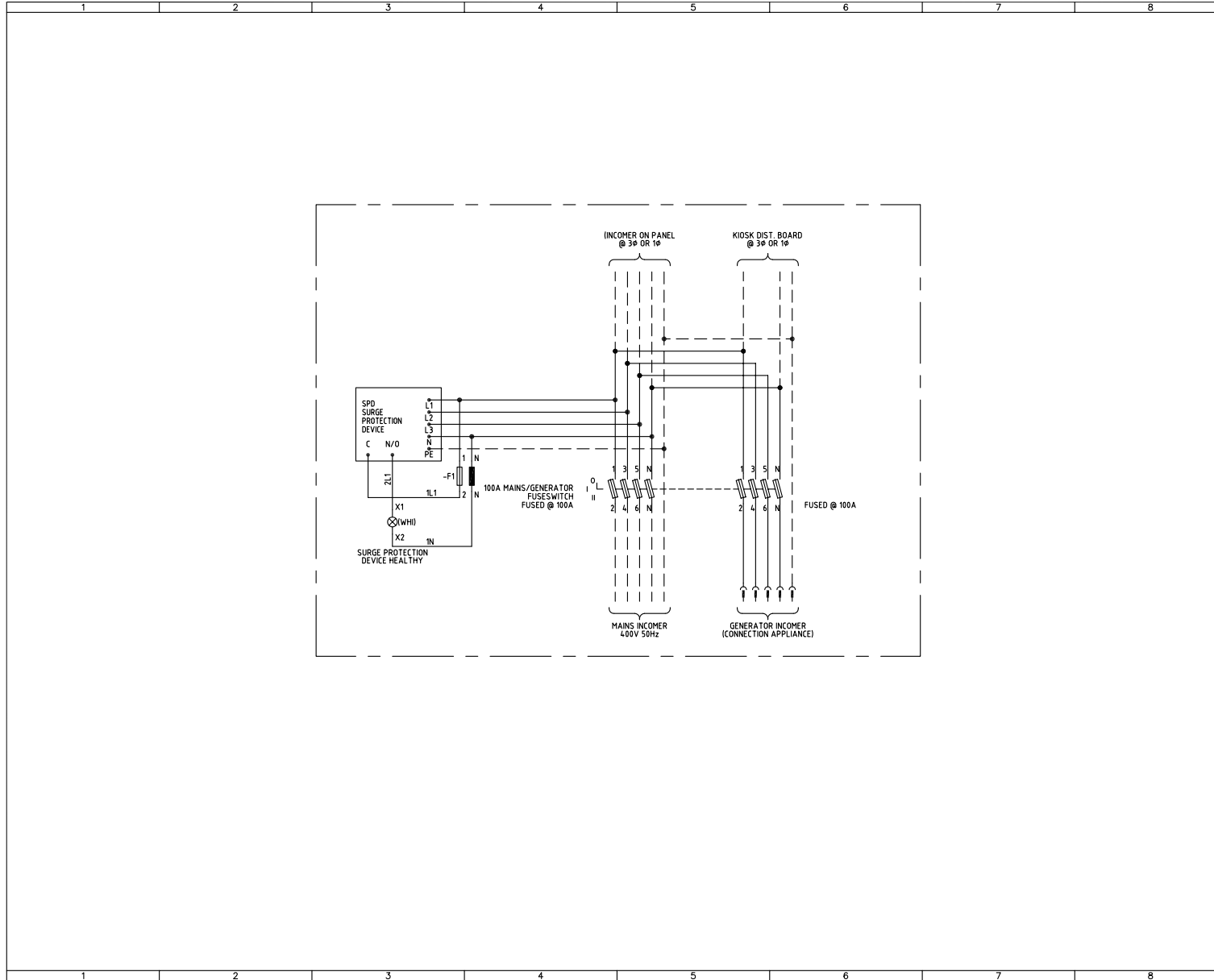

	LLOYD MORRIS ELECTRICAL LTD 2005, TROSCHEE ROAD WIDNES, NORTH WALES LL11 2UD TEL: 443 (0)1778 201505 E-MAIL: info@lloyd-morris.co.uk
	THE DRAWING IS PRIVATE AND CONFIDENTIAL. IT IS SUPPLIED ON THE EXPRESS UNDERSTANDING THAT IT IS NOT TO BE COPIED OR COMMUNICATED TO OTHER PARTIES WITHOUT THE WRITTEN CONSENT OF LLOYD MORRIS ELECTRICAL LTD.

APPROVALS: COP	CHECKED BY: COP
LME DRAWING NO: TEMPLATE-026	

CURRENT ISSUE INFORMATION				
IP01	MAL	DRT	VS FOR GUIDANCE ONLY	05/12/19
0004F	0001	0001	0001	0001
SA	FOR TECHNICAL REVIEW			0001
0004F	0001			0001

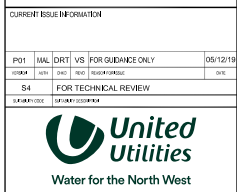

UU SEWERAGE SECTOR DAC GUIDANCE  
 APPENDIX C ADDENDUM  
 MAINS/GENERATOR CHANGEOVER PANEL COP  
 SCHEMATIC DIAGRAM

DATE: N.T.S	DRAWN BY: TBA	CHECKED BY: P01
----------------	------------------	--------------------

© The copyright of this document, which contains information of a proprietary nature, is vested in United Utilities Water PLC. The content of this document may not be used for purposes other than that for which it has been supplied and may not be reproduced, either wholly or in part, in any way whatsoever. It may not be used by, or its contents divulged to any other person whatsoever without the prior written permission of United Utilities Water PLC. Copyright Acknowledgement: Use of Ordnance Survey map data sanctioned by the controller of H.M. Stationery Office. OS Licence Number: 100019326. Crown copyright reserved. Unauthorised production infringes copyright.

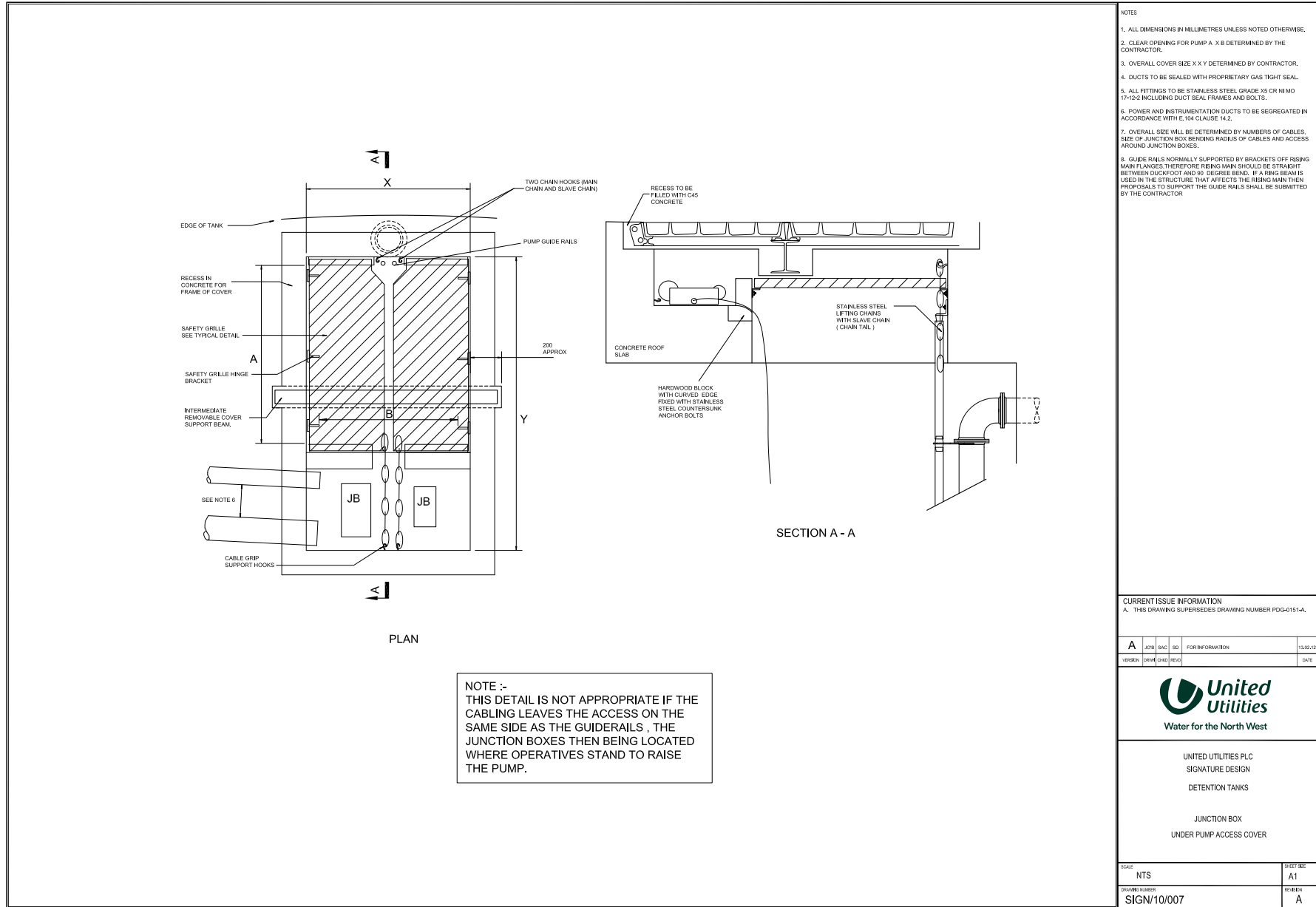

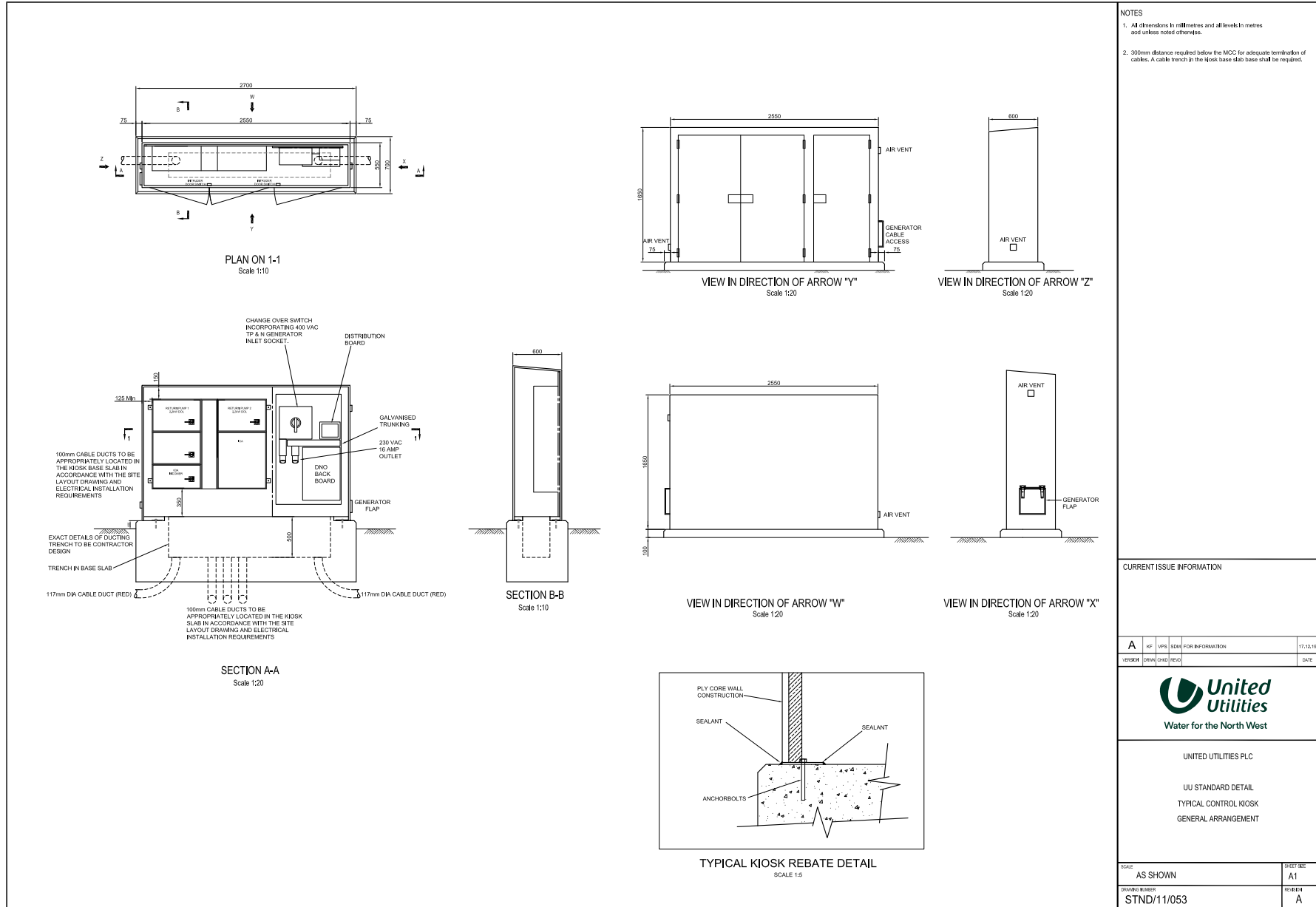

CURRENT ISSUE INFORMATION

A	JP	VPS	SDM	FOR INFORMATION	17.12.19
VERSION	DRAW	CHKD	REV'D	DATE	



UNITED UTILITIES PLC  
UU STANDARD DETAIL  
TYPICAL CONTROL KIOSK  
GENERAL ARRANGEMENT

SCALE	AS SHOWN	SHEET NO.	A1
DRAWING NUMBER	STND/11/053	REVISED	A

© The copyright of this document, which contains information of a proprietary nature, is reserved to United Utilities Water PLC. The content of this document may not be used for purposes other than that for which it has been prepared and may not be reproduced, either whole or in part, in any way whatsoever, it may not be used by, or its contents disclosed to any other person whatsoever without the prior written permission of United Utilities Water PLC. Copyright Acknowledgement: Use of Content Server may data as indicated by the controller of this document. OS Licence Number 100119226. Drawn copyright reserved. Unauthorised production infringes copyright.